

KEYSTONE[®] CONSTRUCTION MANUAL

Keystone Compac[®] and Keystone Standard[®] Units

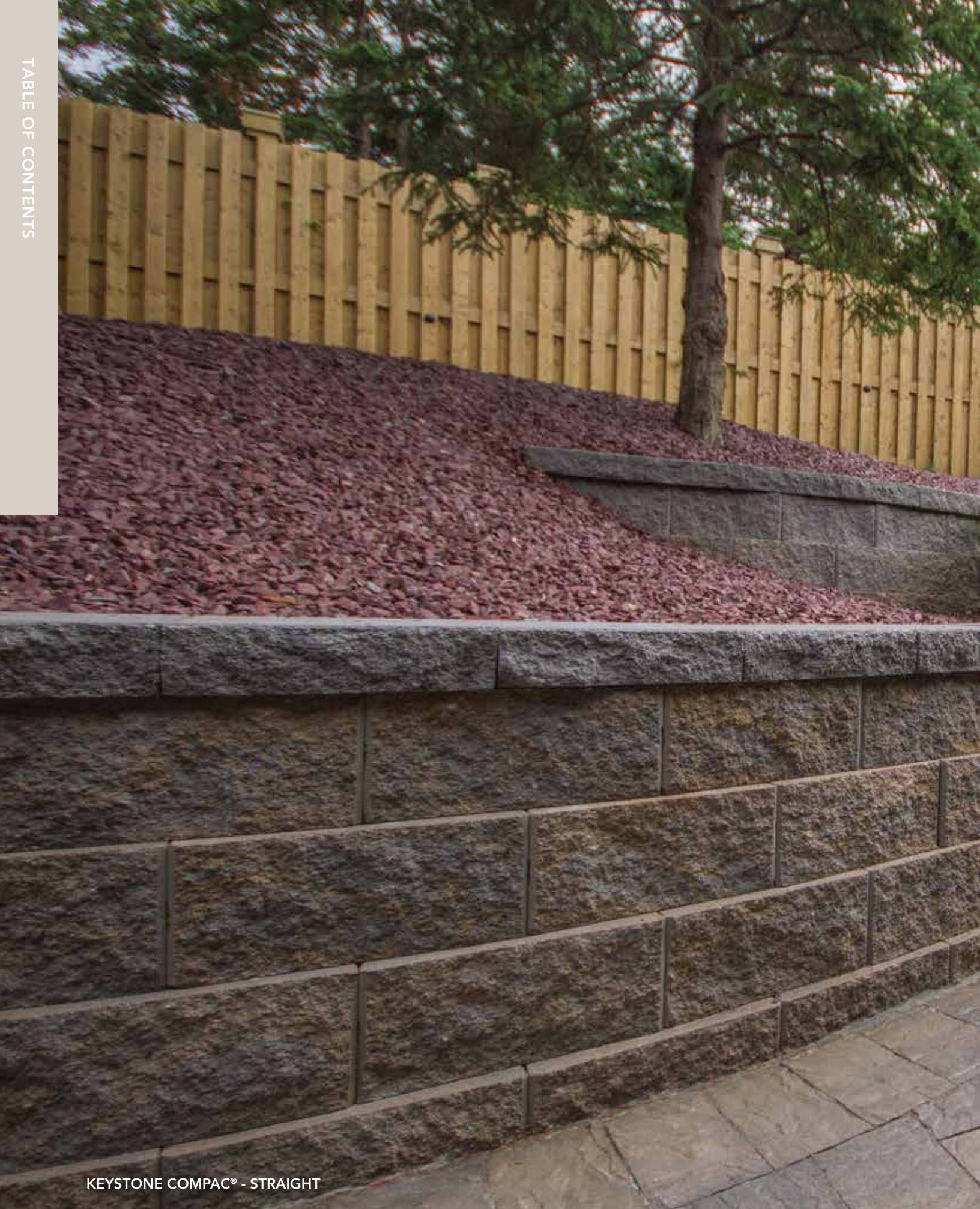



KEYSTONE COMPAC® - STRAIGHT

TABLE OF CONTENTS

Definitions	4
Introduction	6
 Section A: Basic Installation	 9
Installation: Step-by-Step.....	10
 Section B: Design/Estimating Charts	 21
Gravity Walls	22
Reinforced Walls	24
 Section C: Construction of Corners & Curves	 33
90° Outside Corners.....	34
90° Inside Corners	37
Concave (Inside) Curves	40
Convex (Outside) Curves	42
 Section D: Wall Finishing Options	 45
Caps	46
Capping: Straight Walls	48
Capping: Curved Walls	49
 Section E: Common Wall Construction Details	 51
Water Applications	52
Utilities.....	53
Drainage	54
Storm Drain Outlet.....	56
Barriers: Introduction.....	57
Barriers: Guide Rails	57
Barriers: Fencing.....	58
Terraced Walls	59
Planting.....	60
 Segmental Retaining Wall Care, Operations & Maintenance Guide	 62

Definitions

AASHTO – American Association of State Highway and Transportation Officials

ASTM – American Society for Testing and Materials

Backfill – Soil used to replace a zone of excavated soil.

Backslope – The angle of the slope or finished grade located behind the top of the wall, usually expressed in a ratio such as 3:1 (3-foot horizontal to 1-foot vertical) or in degrees, 18.4° or in percent, 33%.

Base Course – First row of Keystone units placed on top of the leveling pad.

CIP – Cast-in-place concrete.

Compaction – Mechanical effort used in densifying soil to a defined minimum percentage of the maximum compacted density of the soil. See ASTM D698 and D1557 for reference.

Core Fill – See Unit Drainage Fill.

Course – A horizontal layer or row of Keystone units.

DOT – Department of Transportation

Drainage Composite – Three-dimensional geosynthetic drainage medium encapsulated in a geotextile filter, used to transport water.

Drainage Pipe – A perforated or slotted PVC pipe manufactured in accordance with ASTM D3034, or corrugated HDPE pipe manufactured in accordance with AASHTO M 252, used to transport water away from the drainage zone or reinforced backfill.

Drainage Zone – A predetermined depth of clean crushed angular stone located within and behind a Keystone unit to prevent the development of hydrostatic forces on the Keystone wall facing. Also see Unit Drainage Fill.

Efflorescence – A whitish substance that can naturally occur on all concrete products. Efflorescence occurs when salts from within the concrete unit are transported to the exterior surface by water or from external chlorides.

Embedment – Depth of retaining wall below existing or proposed ground in front of the wall.

Exposed Wall Face – The exposed visible portion of the retaining wall when installed.

Extensible Reinforcement – See Geogrid.

Foundation Soil – Either in-situ soil or compacted backfill, located beneath wall leveling pad and reinforced fill volume.

Geogrid – A synthetic extensible structural soil reinforcement element formed by a regular network of integrally connected tensile elements with apertures of sufficient size to allow interlocking with surrounding soil, rock, or earth; functions primarily as reinforcement and is typically a HDPE or Polyester material.

Geosynthetics – A range of generally polymeric (plastic) products used to solve civil engineering problems.

Geotextile Filter Fabric – Material is used for a separation and filtration of dissimilar soil types; typically consists in two forms, woven or non-woven synthetic fiber (polymer-based).

Global Stability – The general mass movement of a soil-reinforced retaining wall structure(s) and adjacent soil masses and slopes.

HDPE – High-Density Polyethylene

IBC – International Building Code

Impermeable or Low Permeable Soil – Soil with clay content used to prevent water percolation into the drainage zone and the reinforced backfill behind the retaining wall.

Inextensible Reinforcement – Galvanized steel soil reinforcement.

Keystone unit – A concrete retaining wall element, machine-made from Portland cement, water, and aggregates by a Keystone manufacturer.

Leveling Pad – Material used to support the Keystone unit, typically compacted crushed stone material or unreinforced CIP concrete.

Definitions

Modular Block – See Keystone unit.

MSE – Mechanically Stabilized Earth

NCMA – National Concrete Masonry Association

Parapet – Keystone units or CIP concrete installed above finished grade to create a freestanding wall that does not retain soil.

Polyester – A polymer fiber used in the production of geogrids.

PPE – Personal Protective Equipment, i.e.: hard hat, gloves, eye protection, boots, etc.

PVC – Polyvinyl Chloride; a thermoplastic polymer.

Reinforced Soil (Reinforced Backfill) – Compacted soil that is placed within the reinforced soil volume as outlined on the plans.

Reinforcement – See Geogrid.

Retained Soil – In-situ soil or compacted backfill located directly behind the reinforced soil volume or gravity wall system.

Segmental Wall Unit – See Keystone unit.

SRW – Segmental Retaining Wall; i.e., multiple Keystone units installed to create a retaining wall.

Surcharge – Any loading imposed on the soil behind the wall that exerts an additional force on a wall structure. Surcharge loadings are assumed to be uniform live or dead loads.

Surcharge-slope – Any additional loading imposed on the wall structure due to backslope conditions behind the wall.

Swale – A ditch or depression in the soil at the top or bottom of the retaining wall used to divert water to another location away from the wall.

Toe Slope – The slope angle of the soil located in front of the wall base, usually expressed in a ratio such 3:1 (3-feet horizontal and 1-foot vertical) or in degrees, 18.4° or in percent, 33%.

Unit Drainage Fill – Free-draining crushed stone that is placed within and immediately behind the Keystone concrete units, measuring 2-feet in total depth from the proposed wall face. Also see drainage zone.

Wall Batter – The wall face angle measured in degrees from vertical.

Keystone® Structural Walls

DESIGN AND BUILD WITH CONFIDENCE

Our pinned Keystone structural products includes a comprehensive assortment of face styles to satisfy virtually any aesthetic requirement. Structural retaining walls are where Keystone began. Keystone's retaining wall systems continue to be trusted by engineers, architects and contractors worldwide to provide the best site solutions for commercial, municipal, industrial, transportation/DOT and residential applications.

Keystone Compac Units

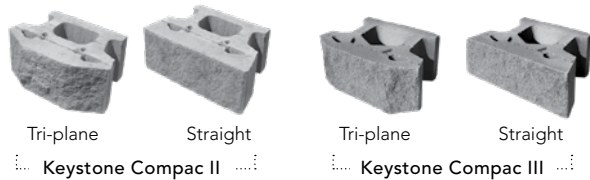

Alternate Face Textures (Compac only)

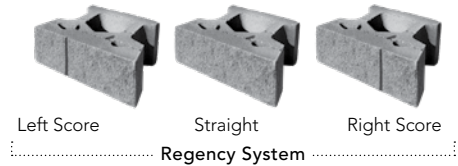

Keystone Standard Units

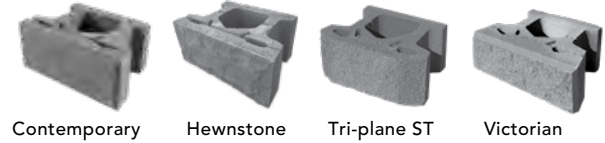
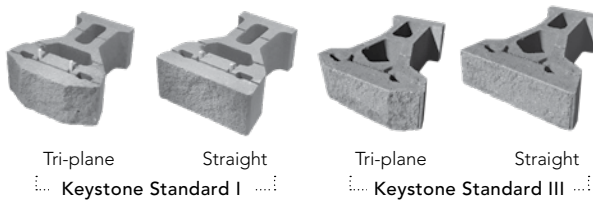

Isometric

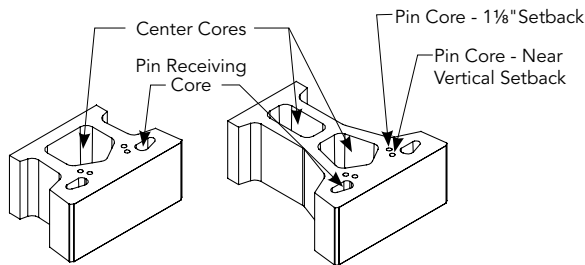

Elevation

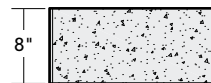

Plan

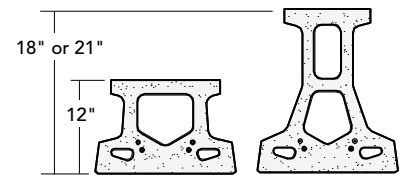

	Height (in)	Width (in)	Depth (in)	Face Area (SF)	Weight (lbs)	Volume of Voids to Tail (CF)
Keystone Compac - Series II	8"	18"	12"	1	81-91	0.35
Keystone Compac - Series III	8"	18"	12"	1	69-77	0.41
Keystone Standard - Series I	8"	18"	18"	1	92-113	0.70
Keystone Standard - Series I	8"	18"	21"	1	97-118	0.90
Keystone Standard - Series III	8"	18"	18"	1	80-93	0.81
Keystone Standard - Series III	8"	18"	21"	1	85-99	1.01

Note: Unit weights, dimensions and availability vary by manufacturer. Please contact your local representative.

The information contained herein has been compiled by Keystone Retaining Wall Systems® LLC and to the best of our knowledge, accurately represents the Keystone product used in the applications which are illustrated. Final determination of the suitability for the use contemplated and its manner of use are the sole responsibility of the user. Design and analysis shall be performed by a qualified engineer.



KEYSTONE STANDARD® STRAIGHT



KEYSTONE COMPAC® REGENCY

BASIC INSTALLATION

This section will take you through the step-by-step process of installing your retaining wall. Covered in this section is a basic gravity wall installation and also installation procedures for geogrid reinforced walls. While this section may not cover every construction issue you may encounter on your project, it gives a basic overview and helpful hints for the installation of a Keystone retaining wall.

Tools and materials that will be required:

- 12-inch, 48-inch, 72-inch levels
- Tape measure
- Shovel
- Excavating equipment
- Personal protective equipment (PPE)
- 5-lb dead blow hammer
- Heavy hammer and masonry cold chisel
- Stringline
- Compaction equipment (determined by size and scope of wall)
- Concrete saw
- Block splitter
- Keystone structural units and caps
- Structural geogrid, if required
- Unit drainage fill
- Backfill material
- Leveling pad material
- Exterior grade concrete adhesive
- Geotextile fabric
- 4-inch drainage pipe

Installation: Step-by-Step

STEP 1



1. Site Examination / Permitting

Select the location and length for the retaining wall. Call before you dig! In the United States, calling 811 before every digging job gets your underground utility lines marked for free and helps prevent undesired consequences. Digging without calling can disrupt service to an entire neighborhood, harm you and those around you and potentially result in fines and repair costs. Take the necessary measurements, prepare plans, research zoning requirements for your area and obtain proper building permits for your project. Local permitting may require a soils investigation and/or engineered documentation and drawings.



STEP 2



2. Excavation / Embedment

Verify that the layout dimensions are correct and excavate to the lines and grades shown on the construction drawings or to field dimensions. Remove all surface vegetation, organic soils and debris, and verify that the foundation subgrade is in proper condition prior to leveling pad installation. Do not proceed with installation until soft soils or any other unsatisfactory conditions have been corrected.

Embedment Recommendations

For small Keystone gravity walls, a minimum of 6-inches embedment is required.

For reinforced soil Keystone walls, the minimum depth of embedment as a ratio to wall height may be determined in the provided table ([page 11](#)).

Installation: Step-by-Step

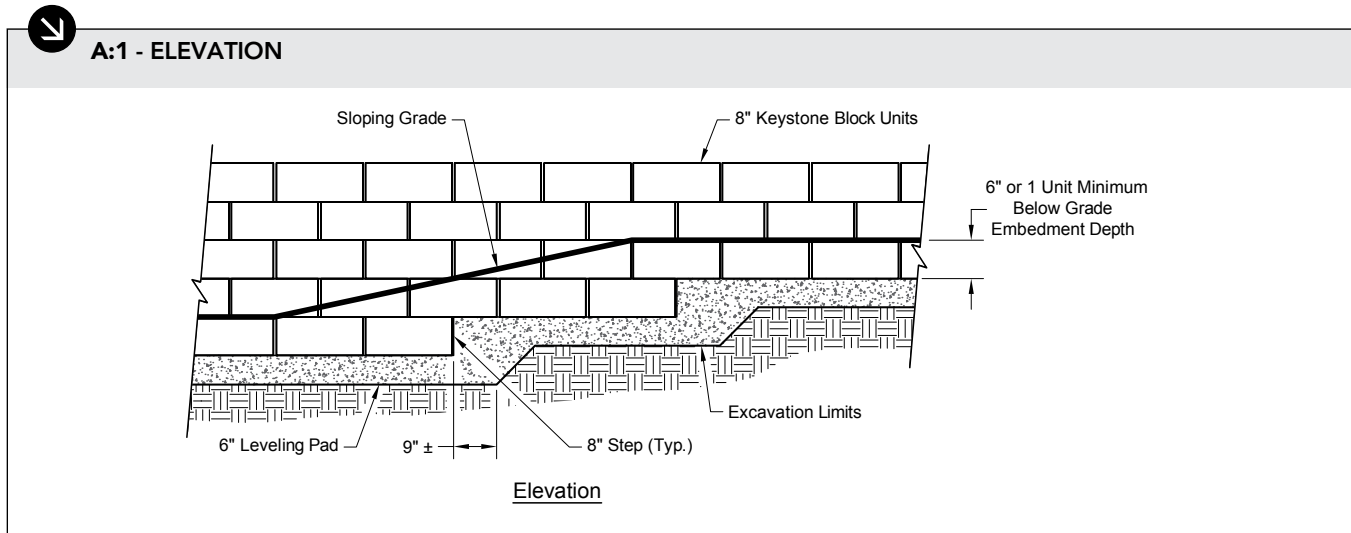

NOTES:

- Project plans, specifications, and design codes may require minimum embedments that exceed the minimums shown here.
- The required embedment depth for Keystone walls may become a controversial issue. The International Building Code (IBC) recommends a 1-foot minimum or below prevailing frost depth, whichever is greater for foundations. AASHTO recommends a 2-foot minimum or below prevailing frost depth, whichever is greater for retaining structures. These minimum recommended depths are based on rigid foundation systems and are not totally applicable to SRWs, which can function properly with significantly less embedment. The proper embedment depth is a function of the structure size and type, the underlying soils, and the site geometry, especially toe slopes. It is important to properly inspect the foundation area when excavated, determine the limits of removal and replacement of unsuitable materials, and then confirm the final embedment depth for stability and bearing given the site conditions.

Sloping Toe

The minimum embedment required with a 3:1 or steeper slope in front of the wall should be based on the establishment of a minimum 4-foot horizontal bench in front of the wall and establishing a minimum embedment from that point. Fill slopes usually have poor compaction near the edge of slope, and all slopes are subject to erosion and superficial instability (see Figure A:2, right).

The depth of embedment should be increased when any of the following conditions occur:

- Weak bearing soils
- Potential scour of wall toe
- Submerged wall applications
- Significant shrink/swell/frost properties of foundation soils
- Global stability concerns

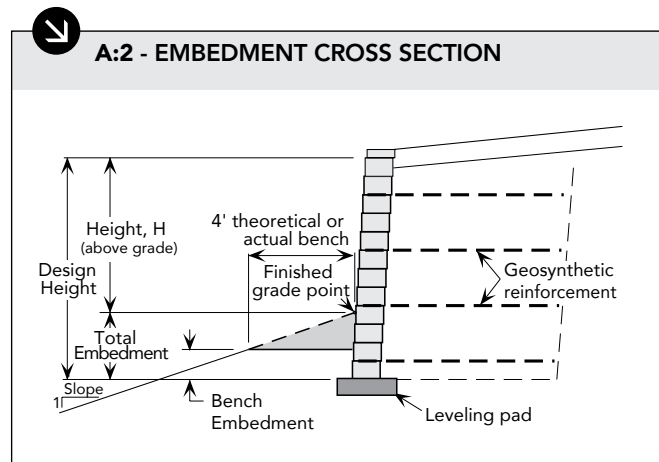

Slope in front of wall	Minimum embedment
Minimum requirement	0.5'
Horizontal (walls)	H/20
Horizontal (abutments)	H/10
3H:1V	H/10 + 1.33'
2H:1V	H/10 + 2'

The information contained herein has been compiled by Keystone Retaining Wall Systems® LLC and to the best of our knowledge, accurately represents the Keystone product used in the applications which are illustrated. Final determination of the suitability for the use contemplated and its manner of use are the sole responsibility of the user. Design and analysis shall be performed by a qualified engineer.

Installation: Step-by-Step



3. Prepare the Base Leveling Pad

Start the leveling pad at the lowest elevation along the wall alignment (see *Figure A:3, below*). The minimum leveling pad width shall be unit depth plus 12 inches. The leveling pad shall be level front-to-back and side-to-side and consist of 6 inches of well-compacted (95% standard proctor or greater) angular granular fill (road base or 1/2-inch to 3/4-inch crushed stone). Lean unreinforced concrete (2,000 psi minimum) is also acceptable to use as a leveling pad. Step the leveling pad up in 8-inch increments at the appropriate elevation change in the foundation. Do not use rounded material (i.e. PEA GRAVEL or SAND) for leveling pad material.

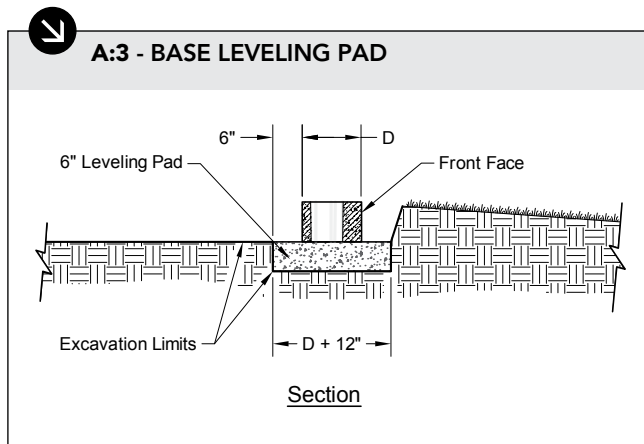

NOTES:

- Construct leveling pad with crushed stone or 2,000 psi \pm unreinforced concrete.
- The leveling pad foundation is to be approved by the site geotechnical engineer prior to leveling pad placement.



4. Install the Base Course

Place the first course of Keystone units (Keystone Compac units shown for illustrative purposes) end-to-end, with face of wall corners touching (do not leave gaps between units) on the prepared base. Ensure that all units are in full contact with the base and properly seated by gently tapping each block corner with the dead blow hammer as required. Level the first course front-to-back, side-to-side, and unit-to-unit down the length of the wall. At base elevation changes, maintain a minimum embedment at step-up locations. A level base course is critical for accurate and acceptable results. (See *Figure A:4, below*.) Lay out corners and curves in accordance with the "Corners and Curves" section of this manual (*page 33*).

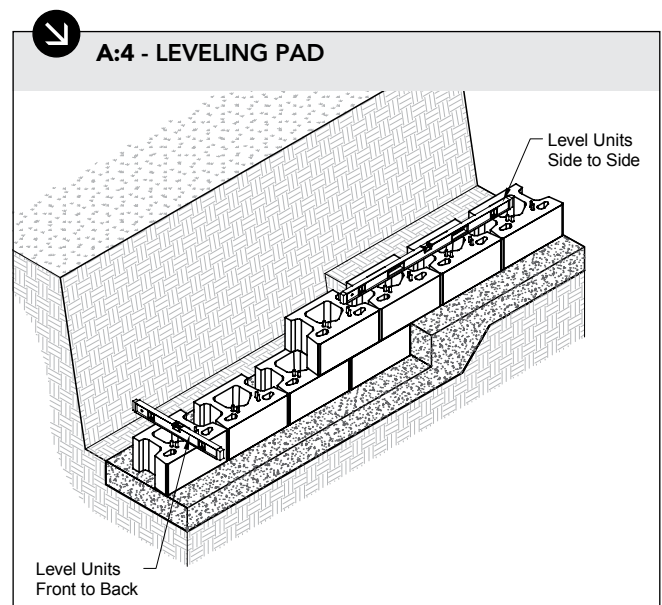

Installation: Step-by-Step

STEP 5



5. Insert the Fiberglass Pins/Drainage Pipe

Keystone units have various facing setback options depending on pinning arrangement used from course to course. Typically near vertical and 8° setback are most common (See Figure A:5, below). For the near vertical option, place the pins in the front pin holes, or for the 8° setback, place the pins in the rear pin holes (See Figure A:6, below). Once placed, the pins create an automatic setback and alignment for the additional courses (See Figures A:5 - A:7, below).

NOTE:

- Place pins prior to placing unit core fill.



A:5 - SETBACK OPTIONS

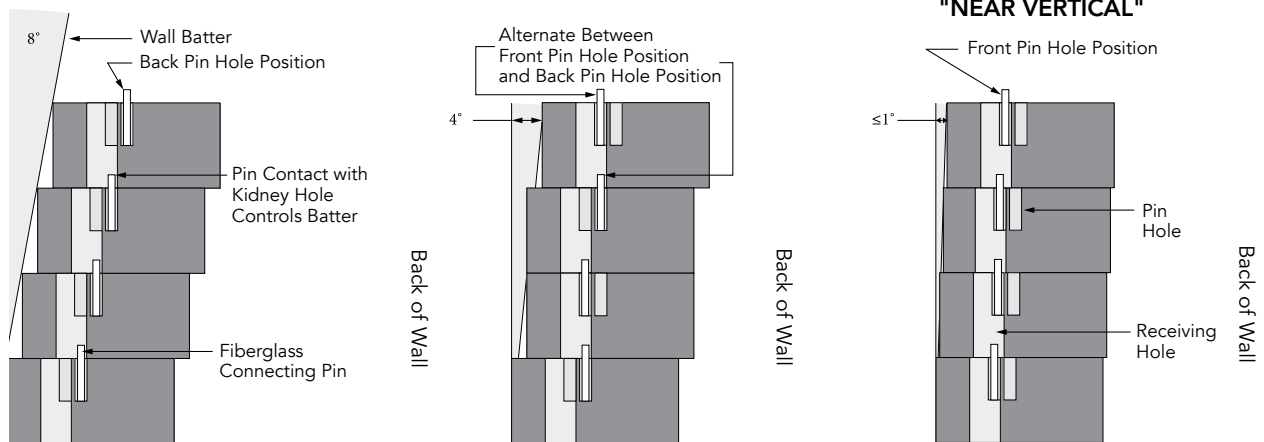

A:6 - PIN INSTALLATION DIAGRAM

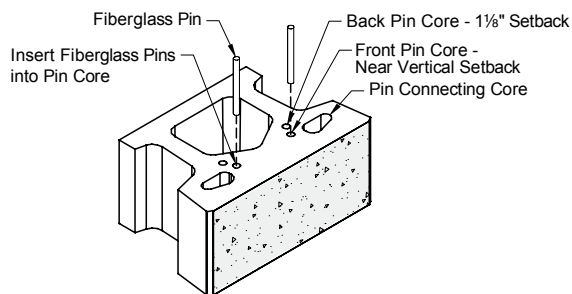

A:7 - CONNECTION DIAGRAM

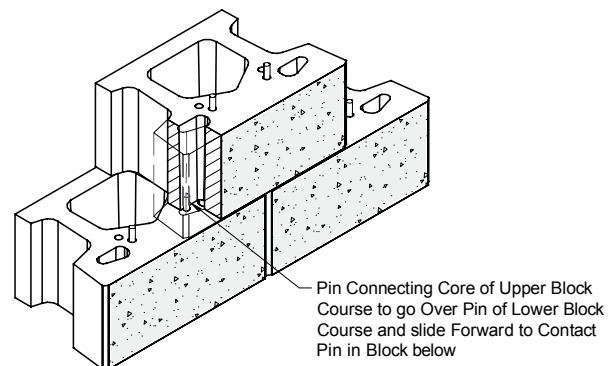

The information contained herein has been compiled by Keystone Retaining Wall Systems® LLC and to the best of our knowledge, accurately represents the Keystone product used in the applications which are illustrated. Final determination of the suitability for the use contemplated and its manner of use are the sole responsibility of the user. Design and analysis shall be performed by a qualified engineer.

Installation: Step-by-Step



6. Install Unit Drainage Fill, Drainage Pipe, Backfill and Compaction

Install drainage pipe behind wall unit and outlet drain to storm system or daylight. See drainage section for additional details ([page 54](#)). Once the pins have been installed, provide ½-¾ inch (13-19mm) crushed stone unit drainage material to a minimum total distance of 24 inches (610mm) from wall face. Fill all open spaces between units and open cavities/cores with the same unit drainage material. Place the wall backfill behind the unit drainage fill in maximum 8 inch (203mm) lifts and compact to 95% Standard Proctor Density or 92% Modified Proctor Density with the appropriate compaction equipment. Use only hand-operated equipment within 3 feet (1m) of the retaining wall face.



A:8 - DRAINAGE PIPE DETAIL

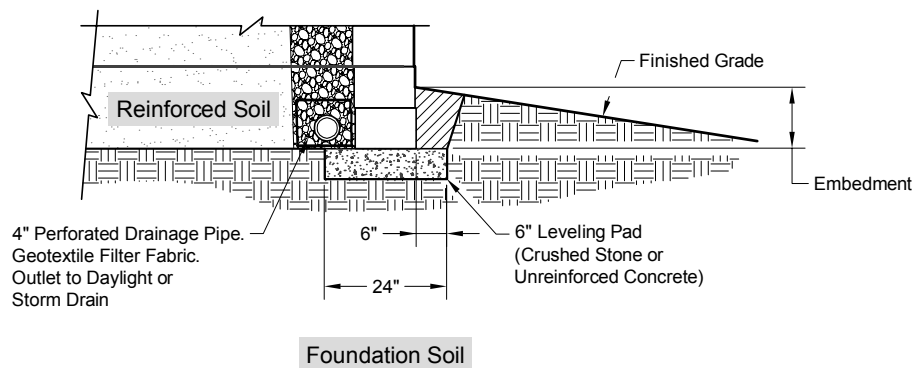

NOTE:

- Drainage pipe should maintain positive drainage to daylight; outlet the drainpipe at low points every 30 to 50-feet on center at ends of wall, if appropriate. Alternatively, a raised drain may be utilized per the detail on [page 55](#) of this manual.

Installation: Step-by-Step

STEP 7



7. Install Additional Courses

Remove all excess unit drainage material from the top surface of all the units. Hold the unit so the pin connecting cores of the upper block insert directly over the pin of the lower block course, and push the unit forward to contact the pins of the lower unit. (See *Figure A:9, below.*) Check level front-to-back and side-to-side, shim the units or grind as necessary. It is important to check level front-to-back and side-to-side on every course to maintain proper wall batter and alignment. Proper shimming materials can be any non-degradable material, including but not limited to, asphalt shingles, scrap pieces of geogrid, etc. Shimming of block is not allowed on courses with geogrid reinforcement.

Continue backfilling, installing additional units and checking level to the desired top elevation. Follow wall unit and unit drainage fill installation closely with backfill. Maximum stacked vertical height of wall units prior to unit drainage fill, backfill placement and compaction shall not exceed 2 courses.

For gravity walls, continue this construction sequence to complete the wall and proceed to Step 10. For geogrid reinforced walls, continue with Step 8 and Step 9.



A:9 - BLOCK CONNECTION DETAIL

Note:

Place two Keystone fiberglass pins in each unit.

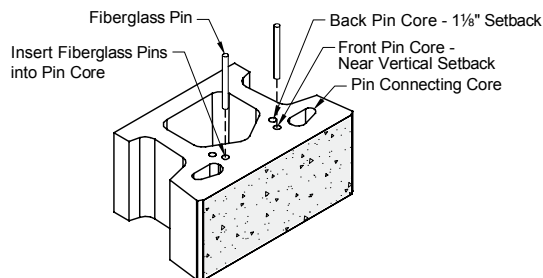
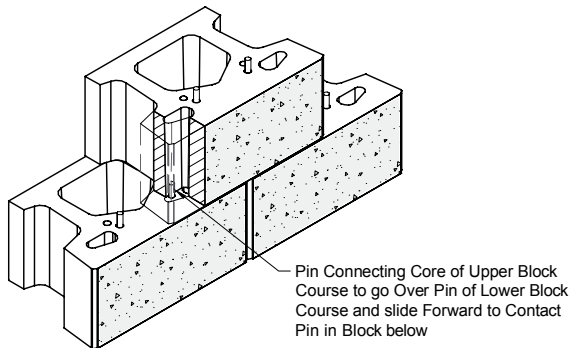

Compac III Block to Block Pin Connections Isometrics

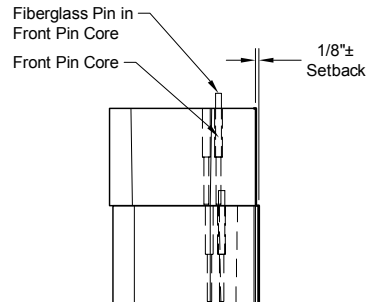

Pin Connection - Near Vertical Setback Section

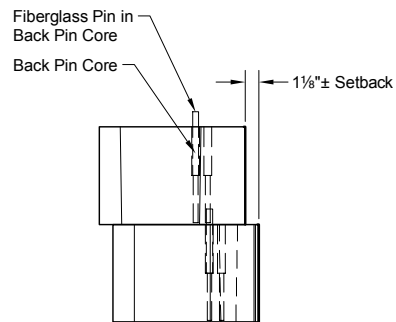

Pin Connection - 1 Inch Setback Section

The information contained herein has been compiled by Keystone Retaining Wall Systems® LLC and to the best of our knowledge, accurately represents the Keystone product used in the applications which are illustrated. Final determination of the suitability for the use contemplated and its manner of use are the sole responsibility of the user. Design and analysis shall be performed by a qualified engineer.

Installation: Step-by-Step

STEP 8



8. Structural Geogrid Installation

Start at the lowest wall elevation where a geogrid layer will be placed. The geogrid elevations, depths, and strength will be specified in the engineered design for the wall. Measure and cut the geogrid material to the specified length. Orient geogrid with highest strength axis perpendicular to the wall alignment. Lay geogrid horizontally on compacted backfill within 1-inch of the face of the lower block (see Figure A:10, below). Ensure that the core fill and unit drainage fill is flush with the top of the lower unit prior to geogrid placement.

Geogrid will be placed in pieces side-by-side (100% coverage) with no gapping or overlapping in a continuous layer along the length of design geogrid elevation, unless a change in elevation is specified in the design.



A:10 - GRID CONNECTION

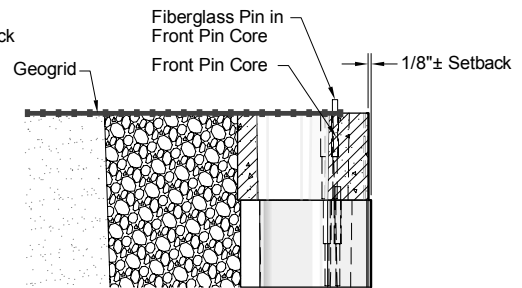
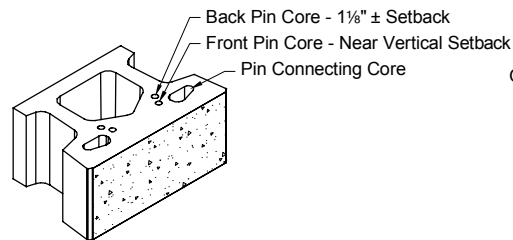

Grid & Pin Connection - Near Vertical Setback Section

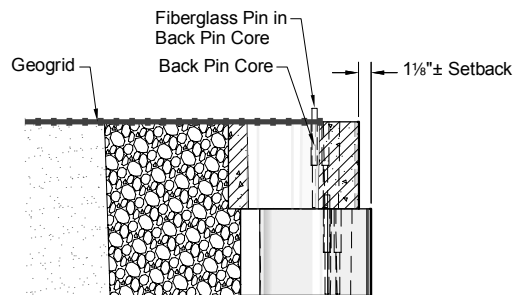
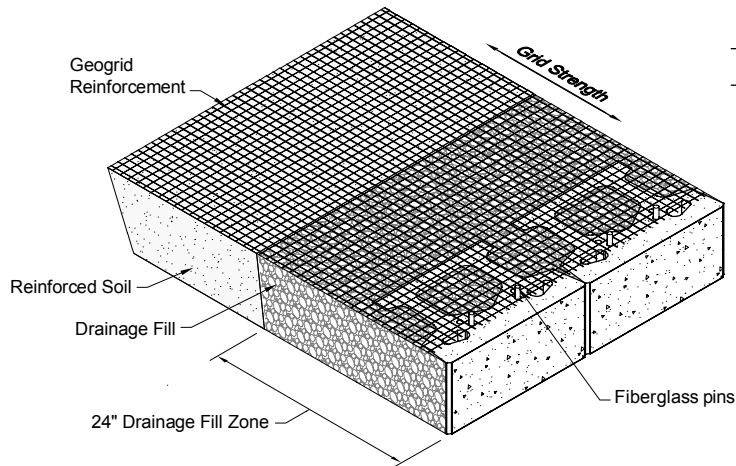

Grid & Pin Connection - 1 1/8 Inch Setback Section

NOTES:

- Geogrid is to be placed on level backfill and extended within 1-inch of the front face of the block unit. Place next unit. Pull grid taut and backfill. Stake as required.
- The roll direction is the strength direction of the geogrid. Geogrid is rolled out perpendicular to wall face.

Installation: Step-by-Step

STEP 9



9. Reinforced Backfill Placement

Install next course of units over the geogrid to secure in place. Tension the geogrid by pulling it towards the embankment. Place a stake through the end of the geogrid into the ground or place fill over the back edge of geogrid to hold it taut and in place. Do not excessively tension geogrid; this may pull units out of proper alignment.

Proceed with placement of the unit drainage fill and the backfill in the reinforced zone. Specifications for the material to be used as backfill in the reinforced zone should be defined in the engineered plans. Place this material nearest to the units, moving progressively toward the staked end of the geogrid. This procedure will keep the geogrid under tension. Compact the reinforced and drainage fill material to a minimum 95% standard proctor density (ASTM D698) or 92% modified proctor density (ASTM D1557). Or see compaction requirements stated in the engineered plans. Install additional courses as described in Step 7, until the next reinforcement elevation. Repeat Steps 8 and 9.

Only hand-operated compaction equipment can be allowed within 3-feet of the back surface of the units. At the end of each day's operation, grade the backfill away from the wall and direct runoff away from the wall face.

STEP 10



10. Capping the Wall

Complete your wall with the appropriate Keystone capping units. These units are available in a variety of sizes and shapes. Availability of these units will vary by region. For cap unit descriptions and placement variations see the section, "Wall Finishing" (page 45) of this manual. Sweep the lower units clean and make sure they are dry. Use exterior grade concrete adhesive on the top surface of the last course before applying cap units (see Figure A:11, below).



A:11 - SECURE THE CAPS

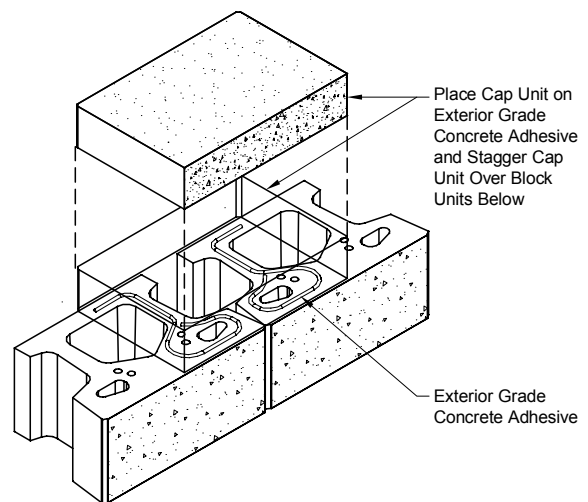

Installation: Step-by-Step

STEP 11



11. Finished Grade and Landscaping

The Keystone retaining wall is now complete. Final grading, planting or other surface material can now be put into place. Typically an 8-inch thick layer of low permeable soil is installed as the final layer of material. This is to help prevent water infiltration into the retained or reinforced zone of the retaining wall. Remember that finished grade conditions affect the wall's performance. Fill placed behind the wall should be graded to flush with the top back of the cap unit. Such conditions should not be altered from the original design.

Loadings that include slopes, parking lots and buildings should be maintained as designed. Any changes to the top-of-wall finished grade must be evaluated prior to wall completion (see *Figures A:12-A:13, page 19*).



KEYSTONE COMPAC® STRAIGHT

The information contained herein has been compiled by Keystone Retaining Wall Systems® LLC and to the best of our knowledge, accurately represents the Keystone product used in the applications which are illustrated. Final determination of the suitability for the use contemplated and its manner of use are the sole responsibility of the user. Design and analysis shall be performed by a qualified engineer.



KEYSTONE COMPAC® STRAIGHT

SECTION B

DESIGN/ESTIMATING CHARTS

This section contains Keystone's design/estimating charts for Keystone Standard® and Keystone Compac® gravity walls or geogrid-reinforced walls. The gravity wall charts help determine the maximum possible gravity wall height before geogrid reinforcement is required.

The wall charts consider multiple factors for determining gravity wall stability and the necessary geogrid length. First, determine the wall load condition that most closely resembles the final project conditions. Then select the soil condition that most closely matches the project site soils. Finally, select the wall height (including embedment) that will best fit the project wall profile.

The design/estimating charts in this section are to be used for reference and preliminary design and estimating only. These charts are not to be considered as a standardized engineering document. A qualified professional should be consulted for final design assistance. Keystone accepts no liability for the use of these charts.

Gravity Wall Schematic

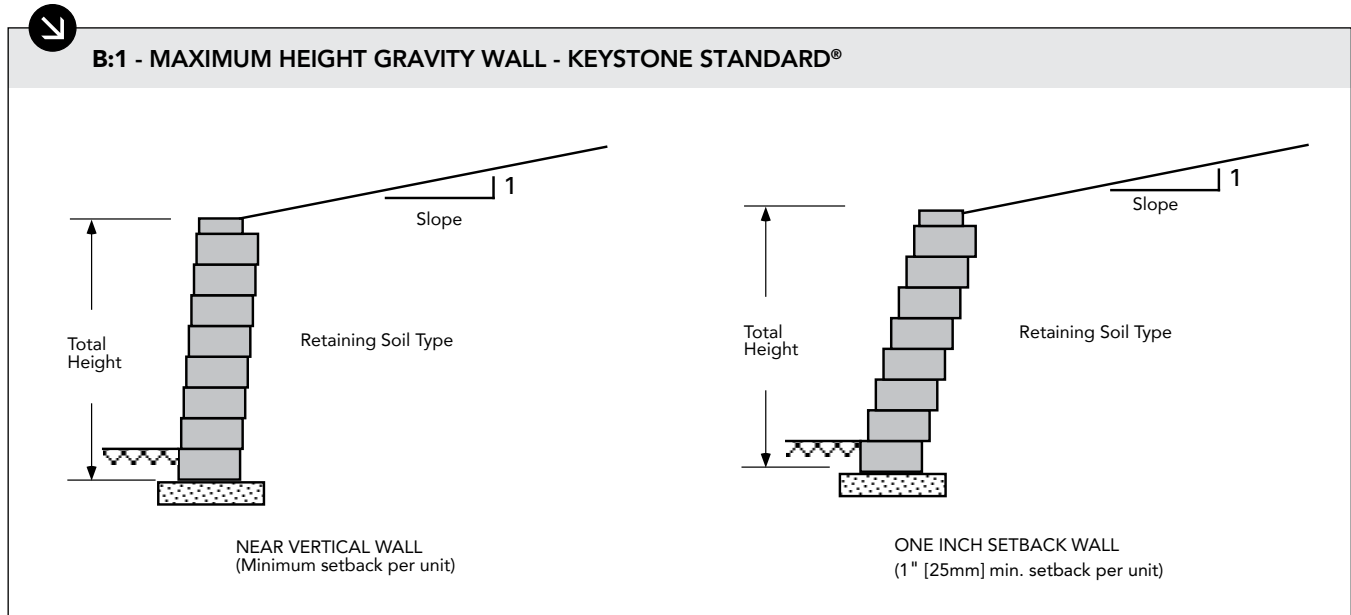

Near Vertical Setback - 18" Depth

MAX HEIGHT	BACKSLOPE				
	Soil Type	Level	4H:1V	3H:1V	2H:1V
Sand/Gravel	5.00'	4.33'	3.67'	3.00'	
Silty Sand	4.33'	3.67'	3.00'	2.33'	
Silt/Lean Clay	3.67'	3.00'	2.33'	1.67'	

1 1/8-inch Setback - 18" Depth

MAX HGT.	BACKSLOPE				
	Soil Type	Level	4H:1V	3H:1V	2H:1V
Sand/Gravel	5.67'	5.00'	5.00'	4.33'	
Silty Sand	5.00'	4.33'	3.67'	3.00'	
Silt/Lean Clay	4.33'	3.00'	3.00'	1.67'	

Near Vertical Setback - 21" Depth

MAX HEIGHT	BACKSLOPE				
	Soil Type	Level	4H:1V	3H:1V	2H:1V
Sand/Gravel	5.67'	5.00'	4.33'	3.67'	
Silty Sand	5.00'	4.33'	3.67'	3.00'	
Silt/Lean Clay	4.33'	3.67'	3.00'	1.67'	

1 1/8-inch Setback - 21" Depth

MAX HGT.	BACKSLOPE				
	Soil Type	Level	4H:1V	3H:1V	2H:1V
Sand/Gravel	7.00'	6.33'	5.67'	5.00'	
Silty Sand	5.67'	5.00'	5.00'	4.33'	
Silt/Lean Clay	5.00'	4.33'	3.67'	3.00'	

NOTES:

- Wall height (H) is the total height from top to bottom.
- Minimum wall embedment should be 6-inches or one unit below grade, whichever is greater. (See page 11)
- Subsurface soils must be capable of supporting wall system.
- Unit drainage fill is 3/4-inch clean crushed stone.
- Leveling pad is crushed stone base material.
- All backfill materials are compacted to minimum 95% standard proctor density or 92% modified proctor density.
- Finished grade must provide positive drainage.
- Calculations assume a unit weight of 120 Pcf for all soil types. Assumed angles for earth pressure calculations are: Sand/Gravel=34°, Silty Sand=30° and Sandy Silt/Lean Clay=26°. Walls are non-critical structures with FS>1.5. Gravity wall charts are performed using Coulomb earth pressure analysis. (NCMA 3rd Edition) Walls utilize 8° batter. No surcharges, except slopes, were used in the analysis.
- Surcharges or special loading conditions will reduce maximum wall heights. Sliding calculations assume a 6-inch crushed stone leveling pad as compacted foundation material. The information provided is for preliminary design use only. A qualified professional should be consulted. Keystone accepts no liability for the use of these tables.

The information contained herein has been compiled by Keystone Retaining Wall Systems® LLC and to the best of our knowledge, accurately represents the Keystone product used in the applications which are illustrated. Final determination of the suitability for the use contemplated and its manner of use are the sole responsibility of the user. Design and analysis shall be performed by a qualified engineer.

Gravity Wall Schematic

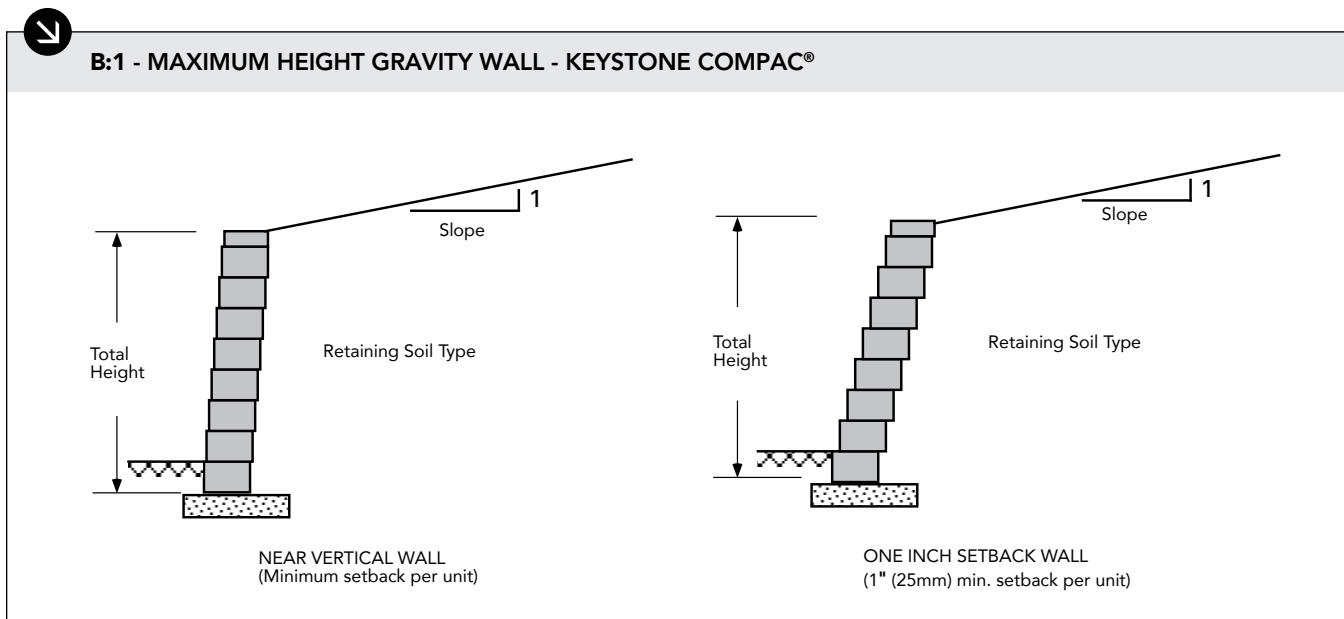

Near Vertical Setback

MAX HEIGHT	BACKSLOPE				
	Soil Type	Level	4H:1V	3H:1V	2H:1V
Sand/Gravel	3.00'	3.00'	3.00'	2.33'	
Silty Sand	3.00'	2.33'	2.33'	1.67'	
Silt/Lean Clay	2.33'	1.67'	1.67'	<1.00'	

1 1/8-inch Setback Option

MAX HGT.	BACKSLOPE				
	Soil Type	Level	4H:1V	3H:1V	2H:1V
Sand/Gravel	3.67'	3.67'	3.00'	3.00'	
Silty Sand	3.00'	2.33'	2.33'	1.67'	
Silt/Lean Clay	2.33'	2.33'	1.67'	<1.00'	

NOTES:

- Wall height (H) is the total height from top to bottom.
- Minimum wall embedment should be 6-inches or one unit below grade, whichever is greater. (See page 11)
- Subsurface soils must be capable of supporting wall system.
- Unit drainage fill is 3/4-inch clean crushed stone.
- Leveling pad is crushed stone base material.
- All backfill materials are compacted to minimum 95% standard proctor density or 92% modified proctor density.
- Finished grade must provide positive drainage.
- Calculations assume a unit weight of 120 Pcf for all soil types. Assumed angles for earth pressure calculations are: Sand/Gravel=34°, Silty Sand=30° and Sandy Silt/Lean Clay=26°. Walls are non-critical structures with FS>1.5. Gravity wall charts are performed using Coulomb earth pressure analysis. (NCMA 3rd Edition) Walls utilize 8° batter. No surcharges, except slopes, were used in the analysis.
- Surcharges or special loading conditions will reduce maximum wall heights. Sliding calculations assume a 6-inch crushed stone leveling pad as compacted foundation material. The information provided is for preliminary design use only. A qualified professional should be consulted. Keystone accepts no liability for the use of these tables.

Design/Estimating Charts: Reinforced Wall Charts

The Keystone reinforced wall charts are graphically presented to show the proper location and lengths of geogrids used with Keystone Standard and Keystone Compac units at near vertical and 1½ inch setback. The chart includes design heights from 4.3 feet tall to 11 feet tall. Engineering judgment should be used when interpolating between heights. In general, geogrid should be placed at the design elevation for the entire wall length or until a wall step is reached. These preliminary design and estimating charts are for individual walls and do not apply to any tiered wall applications.

Minimum reinforcement lengths were set for 4-foot and a 70% reinforcement length-to-wall height ratio. For the Keystone Compac unit, top layers of geogrid shall never be more than 2 units from the top of the wall. Bottom layers of geogrid shall never be more than 2 units from the top of the leveling pad. Soil ranges were selected to approximate good, medium and poor soil conditions to cover the typical design range. Wall height is the total height of the wall from the top of the leveling pad to the top of the wall. The 1½-inch setback charts use Coulomb earth pressure theory, based on NCMA 3rd Edition for calculations. The near vertical charts use Rankine earth pressure theory for calculations. The following charts assume the use of a coated polyester geogrid with a minimum allowable design strength of: LTDS=1,800 plf, Tal=1,200 plf. The following geogrid types are suitable with these design charts: (1) Miragrid 3XT by TC Mirafi, (2) Stratagrid 200 by Strata Systems and (3) Synteen SF35 by Synteen. 250 psf surcharge is applied 6-inches behind the tail of the units.

All geogrid lengths shown are the actual lengths of geogrid required as measured from the front wall face to the end of the geogrid. The charts assume that the walls are constructed in accordance with Keystone specifications and good construction practice. All soil zones (reinforced, retained, and foundation) must be compacted in 8-inch lifts to minimum 95% standard proctor density or 92% modified proctor density as determined by laboratory testing. The information contained in the design/estimating charts are for preliminary design and estimating use only. A qualified professional should be consulted for final design assistance. Keystone accepts no liability for the use of these charts.

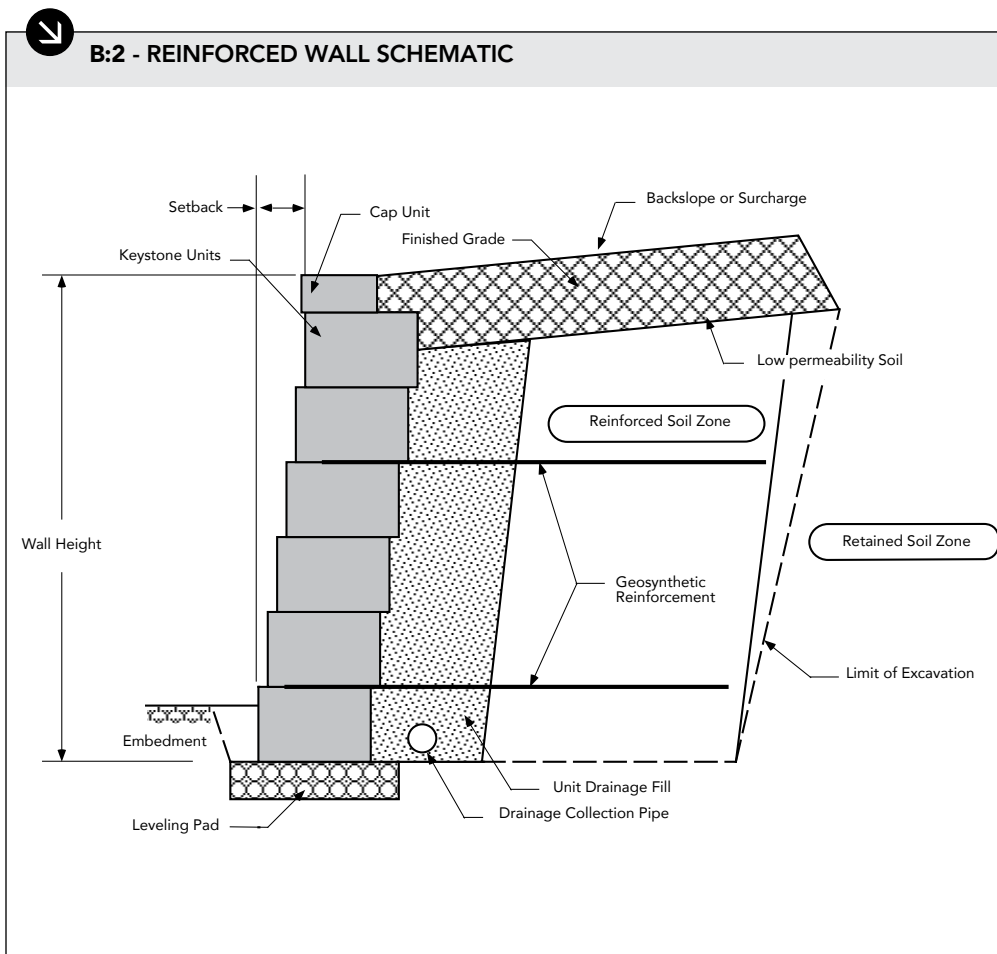

NOTES:

- Wall height (H) is the total height from top to bottom.
- Minimum wall embedment is 6-inches (see page 11).
- Subsurface soils must be capable of supporting the wall system.
- Unit drainage fill is ¾-inch (19mm) clean crushed stone.
- Leveling pad is crushed stone base material.
- All backfill materials are compacted to 95% standard proctor density or 92% modified proctor density.
- Geogrids must be of appropriate type and length per the design.
- Finished grade must provide positive drainage.
- The symbol -(5) indicates location and length of geogrid measured from the front of the wall to the end of the geogrid.

The information contained herein has been compiled by Keystone Retaining Wall Systems® LLC and to the best of our knowledge, accurately represents the Keystone product used in the applications which are illustrated. Final determination of the suitability for the use contemplated and its manner of use are the sole responsibility of the user. Design and analysis shall be performed by a qualified engineer.

Design/Estimating Charts: Reinforced Wall Charts

KEYSTONE STANDARD UNITS - 1 1/8" - INCH SETBACK

SAND/GRAVEL: $\phi=34^\circ$, $\gamma=120$ pcf

CASE 1:
Level - No Surcharge

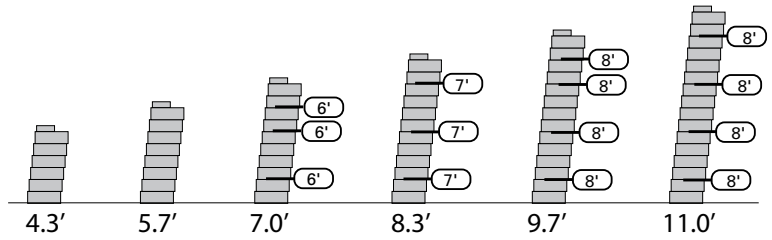
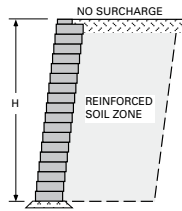

CASE 2:
Level - 250 psf Surcharge

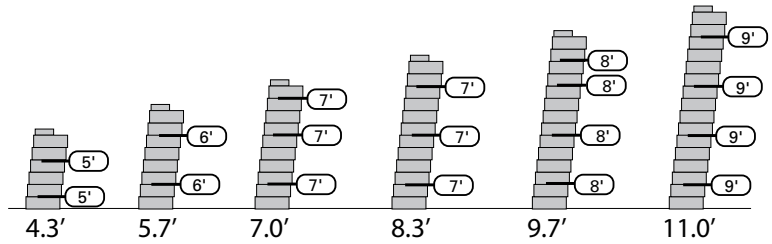
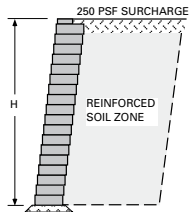

CASE 3:
3H:1V Backslope

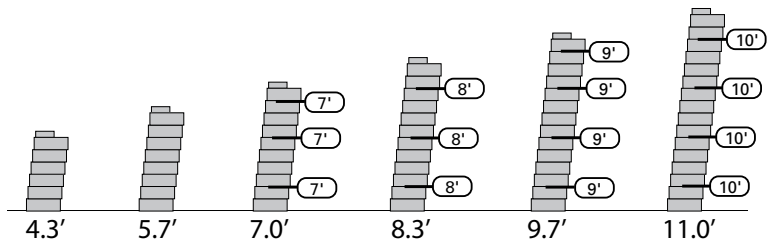
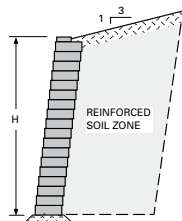

KEYSTONE STANDARD UNITS - 1 1/8" - INCH SETBACK

SILTY SAND: $\phi=30^\circ$, $\gamma=120$ pcf

CASE 1:
Level - No Surcharge

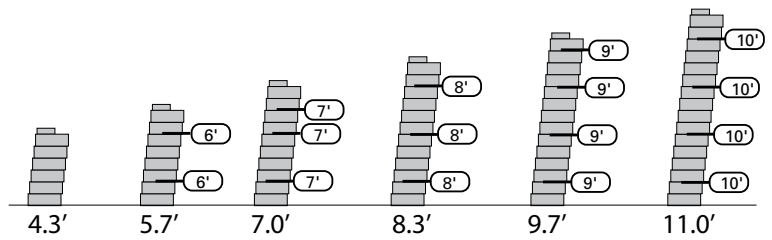
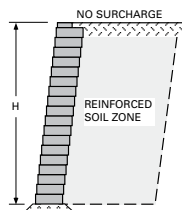

CASE 2:
Level - 250 psf Surcharge

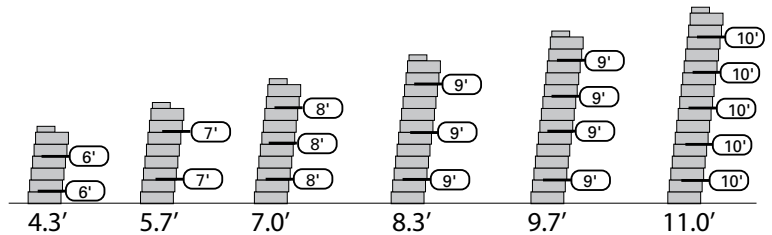
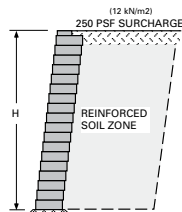

CASE 3:
3H:1V Backslope

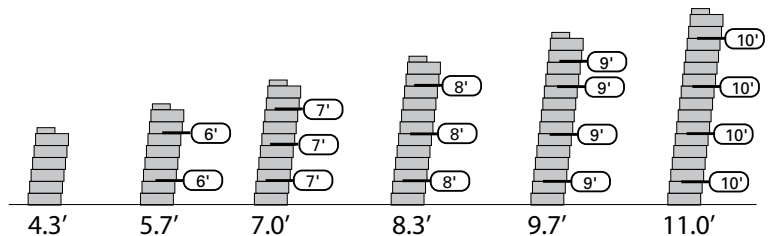
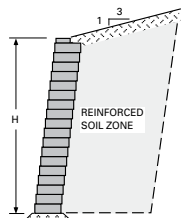

The information contained herein has been compiled by Keystone Retaining Wall Systems® LLC and to the best of our knowledge, accurately represents the Keystone product used in the applications which are illustrated. Final determination of the suitability for the use contemplated and its manner of use are the sole responsibility of the user. Design and analysis shall be performed by a qualified engineer.

Design/Estimating Charts: Reinforced Wall Charts

KEYSTONE STANDARD UNITS - 1 1/8" - INCH SETBACK

SILT/LEAN CLAY: $\phi=26^\circ$, $\gamma=120$ pcf

CASE 1:
Level - No Surcharge

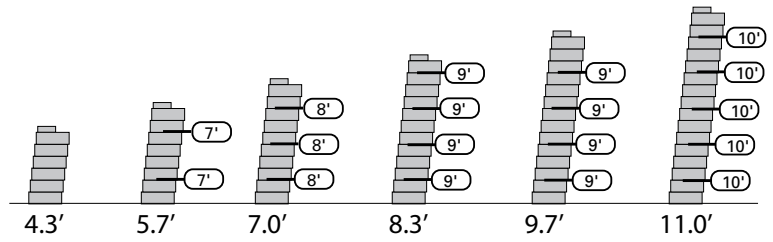
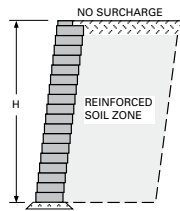

CASE 2:
Level - 250 psf Surcharge

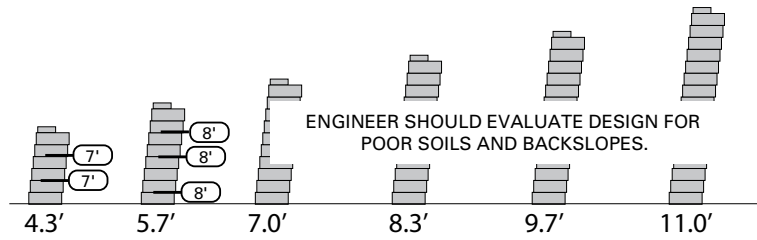
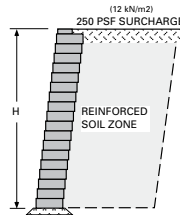

CASE 3:
3H:1V Backslope

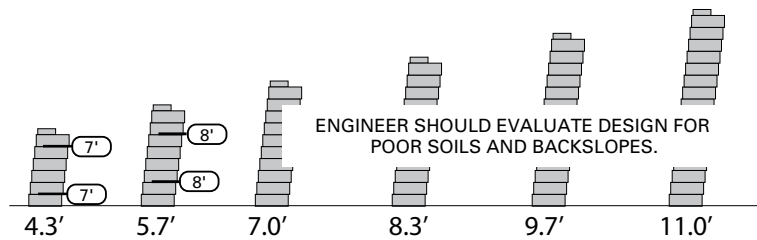
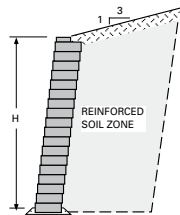

KEYSTONE STANDARD UNITS - NEAR VERTICAL

SAND/GRAVEL: $\phi=34^\circ$, $\gamma=120$ pcf

CASE 1:
Level - No Surcharge

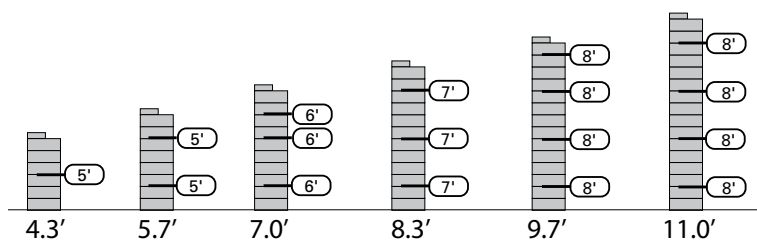
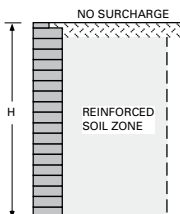

CASE 2:
Level - 250 psf Surcharge

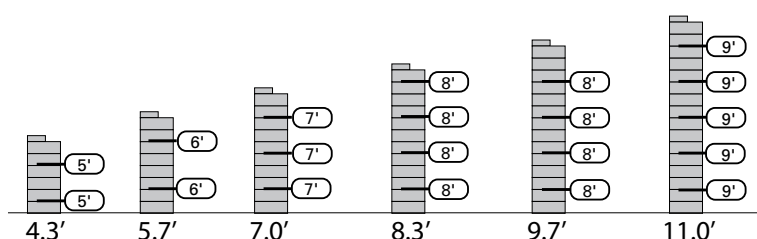
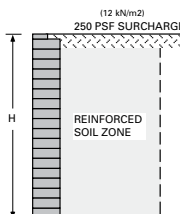

CASE 3:
3H:1V Backslope

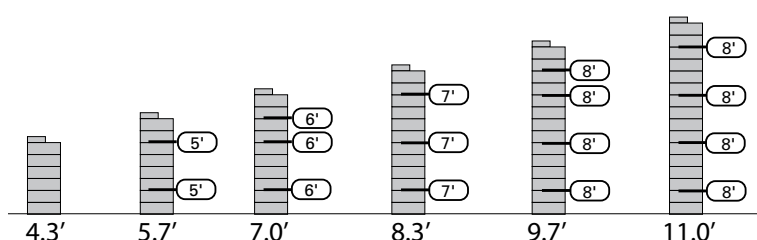
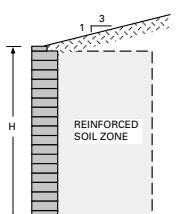

The information contained herein has been compiled by Keystone Retaining Wall Systems® LLC and to the best of our knowledge, accurately represents the Keystone product used in the applications which are illustrated. Final determination of the suitability for the use contemplated and its manner of use are the sole responsibility of the user. Design and analysis shall be performed by a qualified engineer.

Design/Estimating Charts: Reinforced Wall Charts

KEYSTONE STANDARD UNITS - NEAR VERTICAL

SILTY SAND: $\phi=30^\circ$, $\gamma=120$ pcf

CASE 1:
Level - No Surcharge

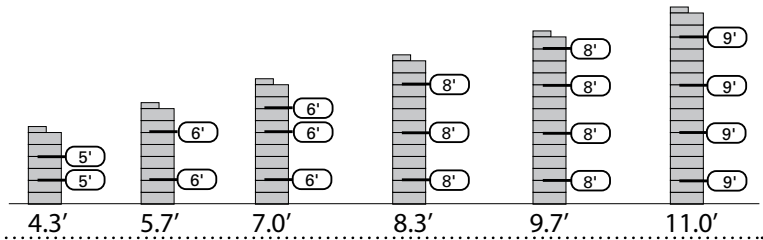
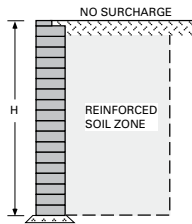

CASE 2:
Level - 250 psf Surcharge

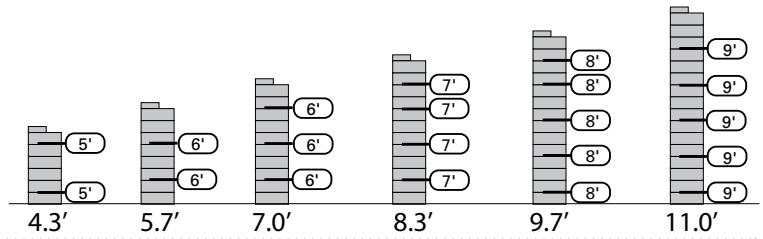
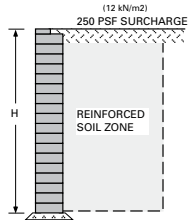

CASE 3:
3H:1V Backslope

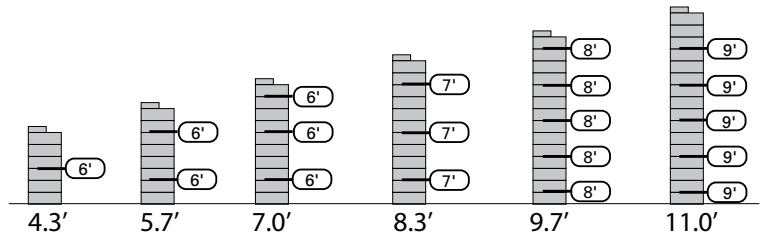
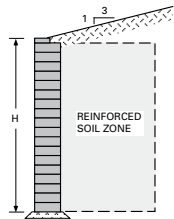

KEYSTONE STANDARD UNITS - NEAR VERTICAL

SILT/LEAN CLAY: $\phi=26^\circ$, $\gamma=120$ pcf

CASE 1:
Level - No Surcharge

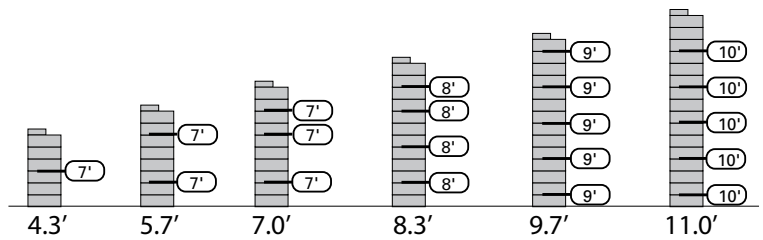
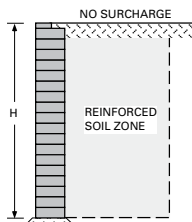

CASE 2:
Level - 250 psf Surcharge

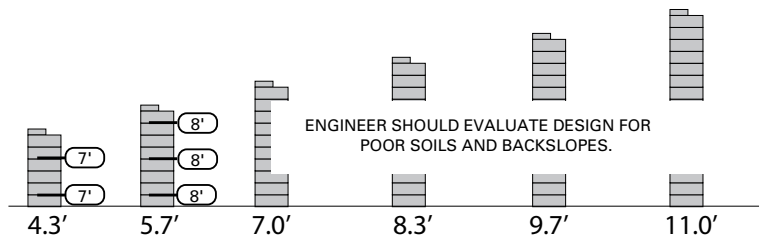
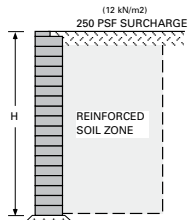

CASE 3:
3H:1V Backslope

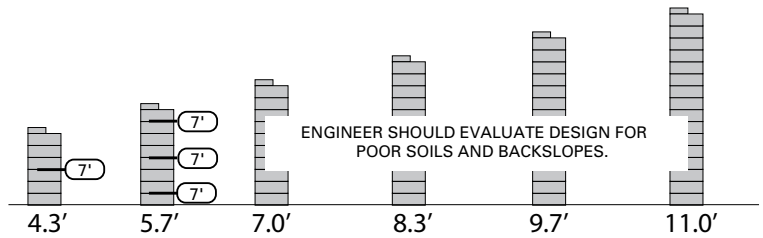
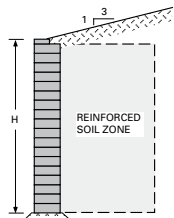

The information contained herein has been compiled by Keystone Retaining Wall Systems® LLC and to the best of our knowledge, accurately represents the Keystone product used in the applications which are illustrated. Final determination of the suitability for the use contemplated and its manner of use are the sole responsibility of the user. Design and analysis shall be performed by a qualified engineer.

Design/Estimating Charts: Reinforced Wall Charts

KEYSTONE COMPAC UNITS - 1 1/8 - INCH SETBACK

SAND/GRAVEL: $\phi=34^\circ$, $\gamma=120$ pcf

CASE 1:
Level - No Surcharge

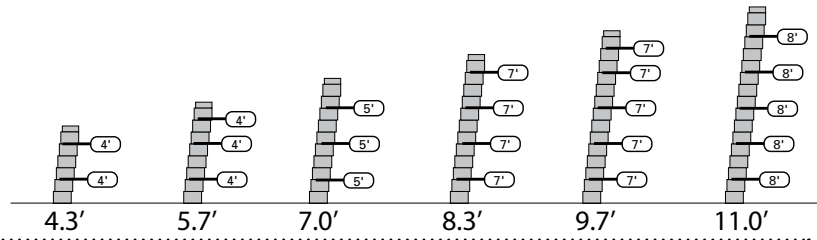
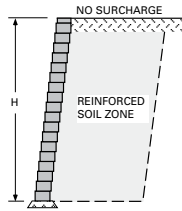

CASE 2:
Level - 250 psf Surcharge

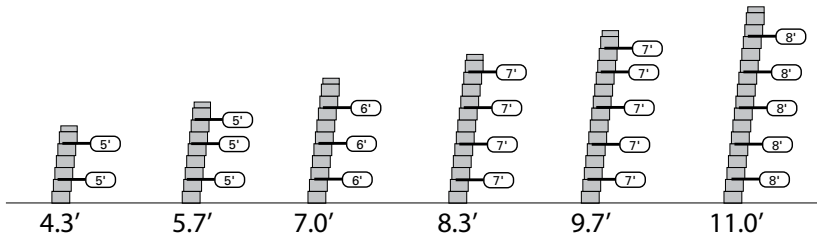
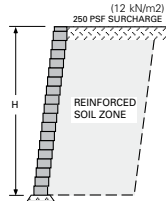

CASE 3:
3H:1V Backslope

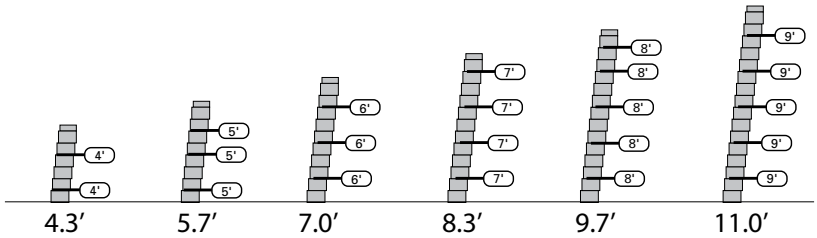
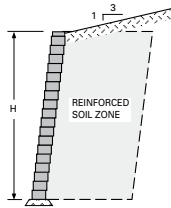

KEYSTONE COMPAC UNITS - 1 1/8 - INCH SETBACK

SILTY SAND: $\phi=30^\circ$, $\gamma=120$ pcf

CASE 1:
Level - No Surcharge

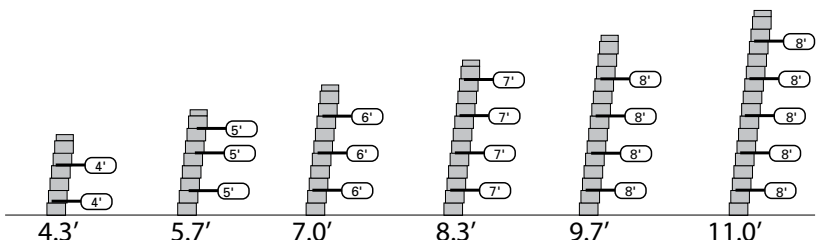
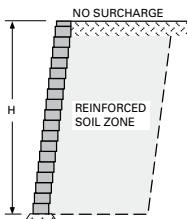

CASE 2:
Level - 250 psf Surcharge

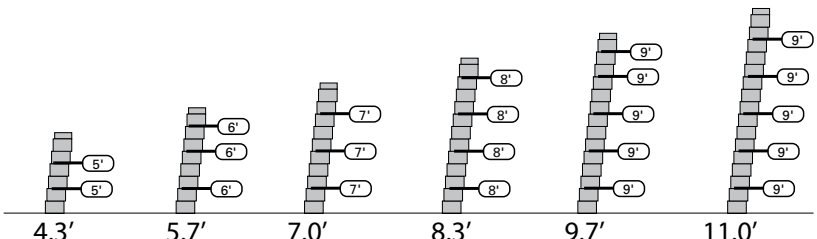
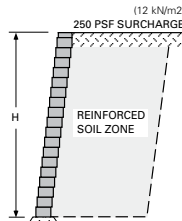

CASE 3:
3H:1V Backslope

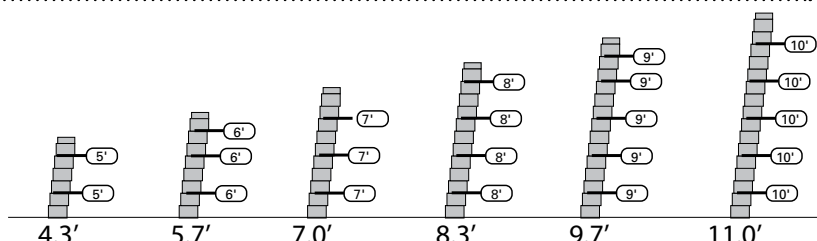
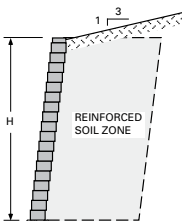

The information contained herein has been compiled by Keystone Retaining Wall Systems® LLC and to the best of our knowledge, accurately represents the Keystone product used in the applications which are illustrated. Final determination of the suitability for the use contemplated and its manner of use are the sole responsibility of the user. Design and analysis shall be performed by a qualified engineer.

Design/Estimating Charts: Reinforced Wall Charts

KEYSTONE COMPAC UNITS - 1 1/8" - INCH SETBACK

SILT/LEAN CLAY: $\phi=26^\circ$, $\gamma=120$ pcf

CASE 1:
Level - No Surcharge

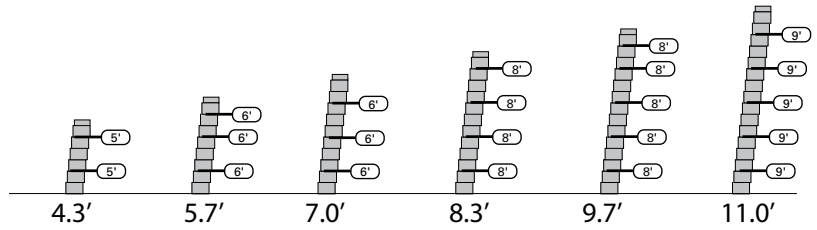
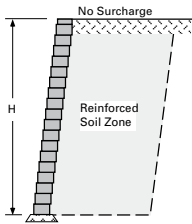

CASE 2:
Level - 250 psf Surcharge

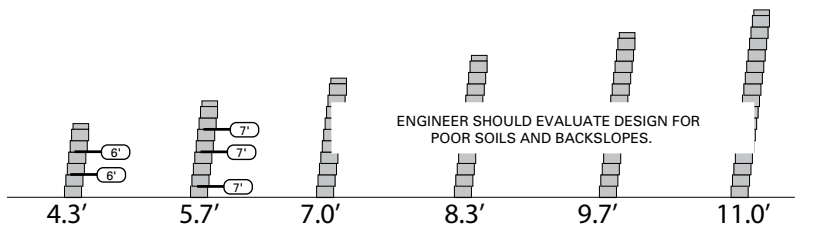
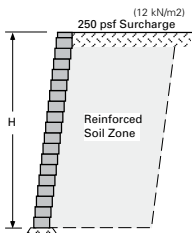

CASE 3:
3H:1V Backslope

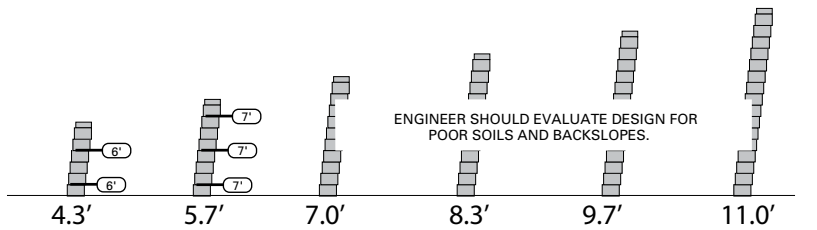
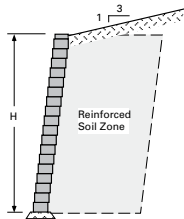

KEYSTONE COMPAC UNITS - NEAR VERTICAL

SAND/GRAVEL: $\phi=34^\circ$, $\gamma=120$ pcf

CASE 1:
Level - No Surcharge

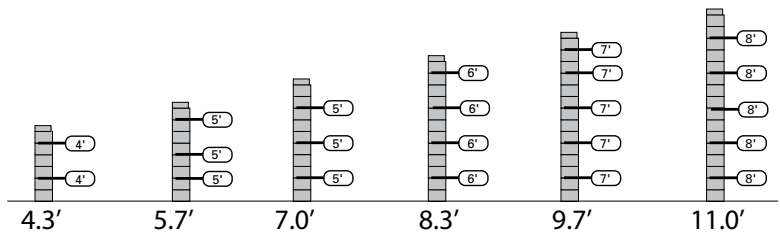
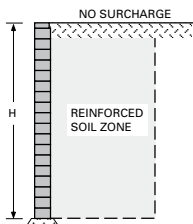

CASE 2:
Level - 250 psf Surcharge

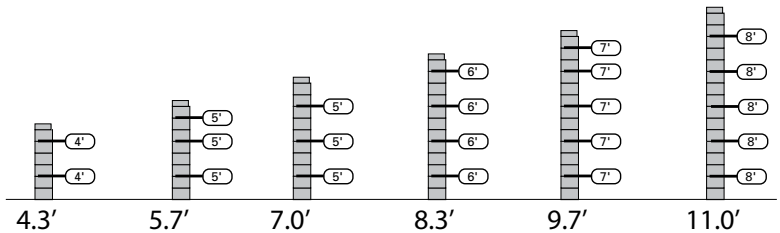
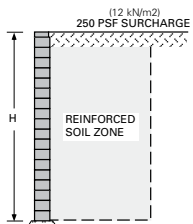

CASE 3:
3H:1V Backslope

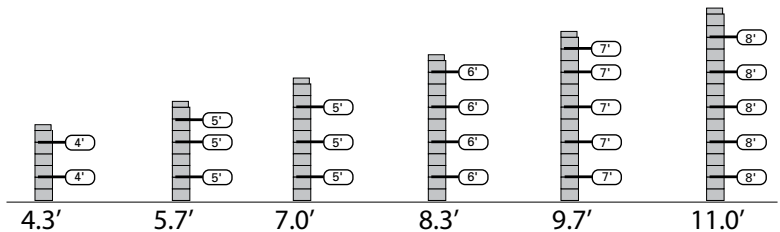
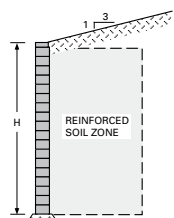

The information contained herein has been compiled by Keystone Retaining Wall Systems® LLC and to the best of our knowledge, accurately represents the Keystone product used in the applications which are illustrated. Final determination of the suitability for the use contemplated and its manner of use are the sole responsibility of the user. Design and analysis shall be performed by a qualified engineer.

Design/Estimating Charts: Reinforced Wall Charts

KEYSTONE COMPAC UNITS - NEAR VERTICAL

SILTY SAND: $\phi=30^\circ$, $\gamma=120$ pcf

CASE 1:
Level - No Surcharge

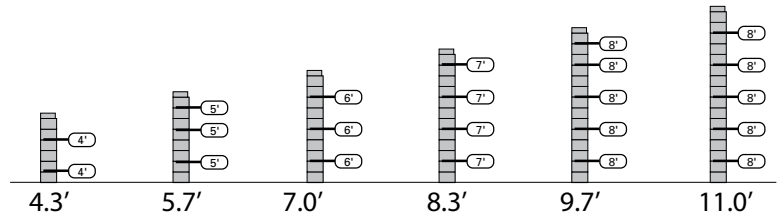
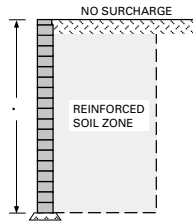

CASE 2:
Level - 250 psf Surcharge

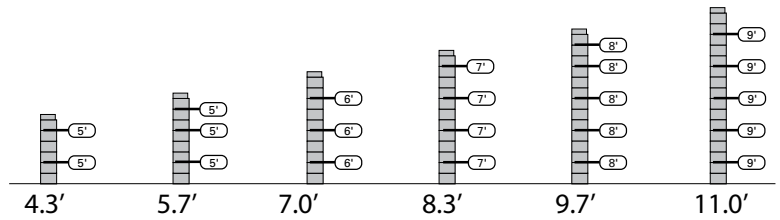
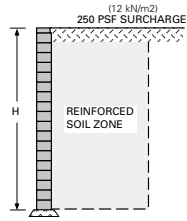

CASE 3:
3H:1V Backslope

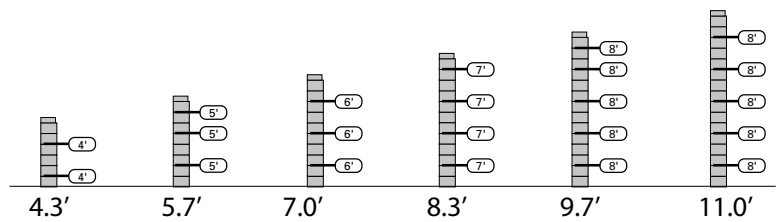
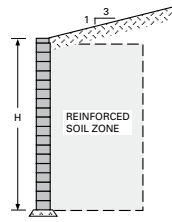

KEYSTONE COMPAC UNITS - NEAR VERTICAL

SILT/LEAN CLAY: $\phi=26^\circ$, $\gamma=120$ pcf

CASE 1:
Level - No Surcharge

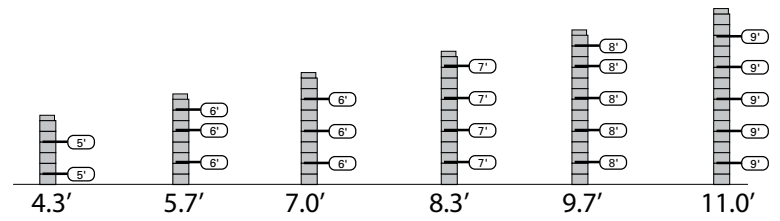
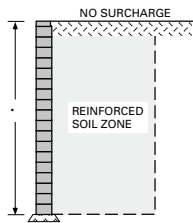

CASE 2:
Level - 250 psf Surcharge

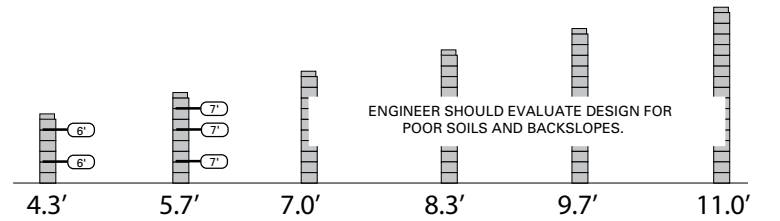
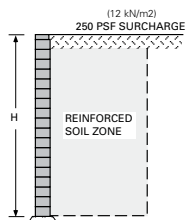

CASE 3:
3H:1V Backslope

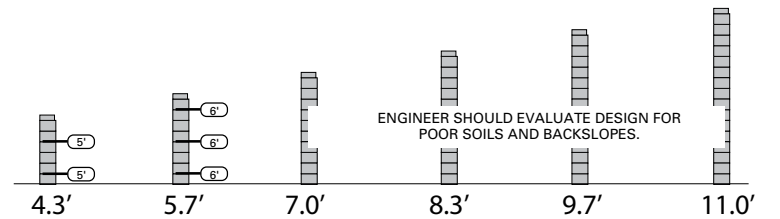
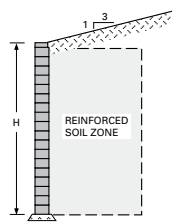

The information contained herein has been compiled by Keystone Retaining Wall Systems® LLC and to the best of our knowledge, accurately represents the Keystone product used in the applications which are illustrated. Final determination of the suitability for the use contemplated and its manner of use are the sole responsibility of the user. Design and analysis shall be performed by a qualified engineer.

Children's Hospital Colorado South Campus



KEYSTONE COMPAC® STRAIGHT



KEYSTONE STANDARD® TRI-PLANE

SECTION C

CONSTRUCTION OF CORNERS & CURVES

So far the discussion regarding the installation of a Keystone retaining wall has centered on the installation of units through the straight line sections of the wall. Equally important to the final aesthetic and function of any wall is the construction of corners and curves.

A corner is typically constructed as either an outside 90° corner or inside 90° corner. When a wall needs to make a turn greater than 90° or less than 75° it is recommended that a radius curve be utilized. For curves in the wall, Keystone units typically have a minimum radius depending on the face style. The flexibility of the Keystone units allows for the construction of multiple corners or curves within the same wall. The following information will provide a general explanation of construction techniques for building retaining walls with corner and curve layouts.

90° Outside Corner: Installation Details

For ease of construction of outside 90° corners, Keystone producers typically provide a corner unit specifically designed for this purpose. Corner unit options and product designs may vary by manufacturer; please contact your local manufacturer for availability before you begin your project planning. Details below show a typical corner unit available in many locations. If corner units are not available, Keystone recommends transitioning the wall from a corner to a radius curve in the wall and avoiding mitered corners. This will enable the wall to maintain its connection integrity and running bond wall configuration for continued wall stability and performance. Please contact your local Keystone representative for assistance if corner units are not available.

Due to the fixed wall batter (1 deg or 8 deg.), as the wall rises vertically, it creates a need to trim structural units on both sides of the corner to maintain a proper running bond pattern in the straight sections of the wall. There will be less trimming necessary in the near vertical position vs. the 1½ inch setback position. Keystone has developed an illustration to show the proper location for trimmed units. This illustration is based on a full running bond pattern on the base course, with no trimmed units. In the case of two corners near each other, it is best to set each corner unit base first to establish corner location, and then set the base course of structural units running to the corners and trim units as necessary.

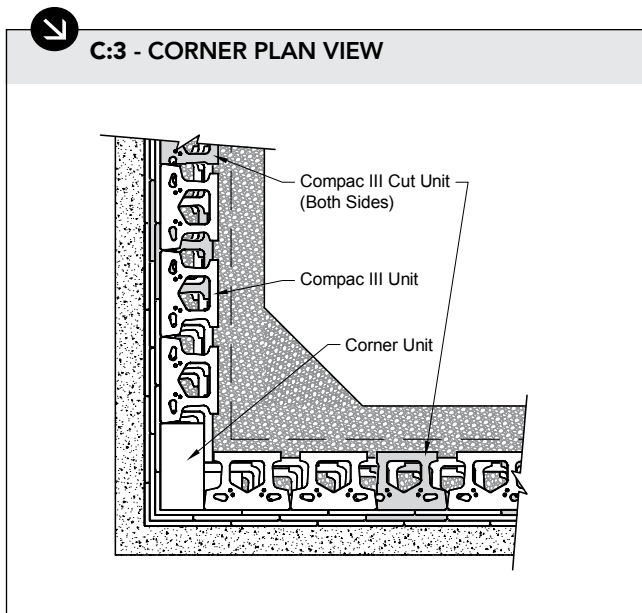
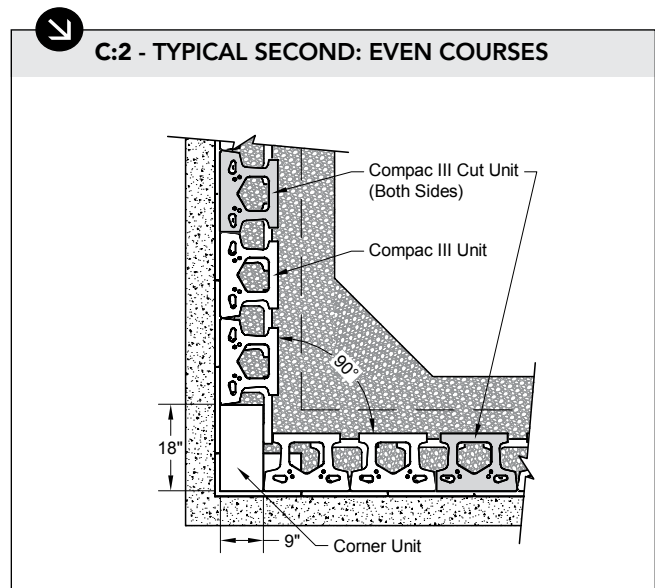
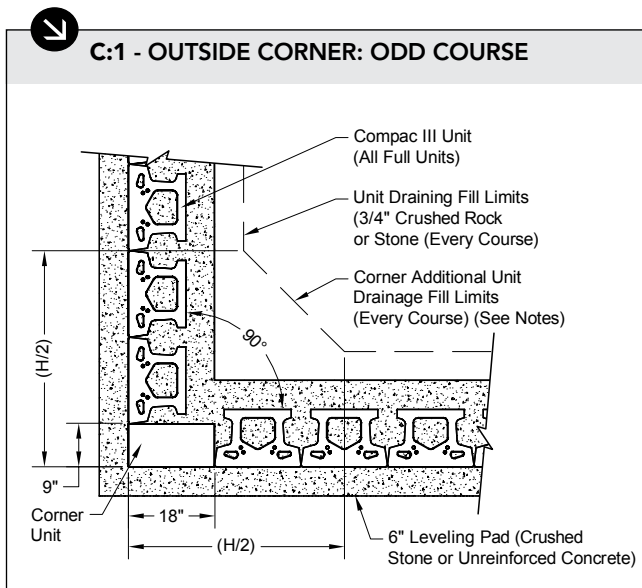

NOTES:

- Full uncut units to be used for the base course and as indicated in the details vertically up the wall corner.
- Due to corner perpendicular wall setback per course, trimming units is necessary to maintain running bond course alignment. Trim adjoining block units a minimum of 1 corner unit and 2 or more full units away from the corner in both directions for proper wall joint alignment. Do not stack cut pieces. Stagger cut units as needed.
- Shaded units are for cut unit designation. Cut units shall not be less than 6-inches in width.
- Secure corner units, and all cut units, together with exterior grade concrete adhesive.
- Verify actual cut lengths as wall is constructed.
- Place additional unit drainage fill at outside wall corners to extend back from wall face each way, a distance equal to the wall height / 2, (H/2).

90° Outside Corner: Installation Details



C:4 - OUTSIDE CORNER: CUT UNIT DIAGRAM

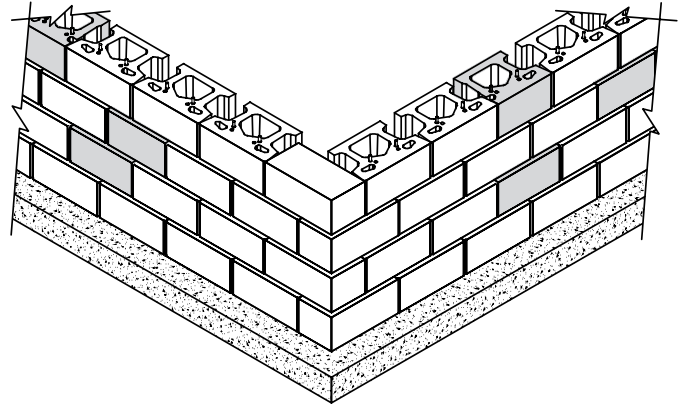
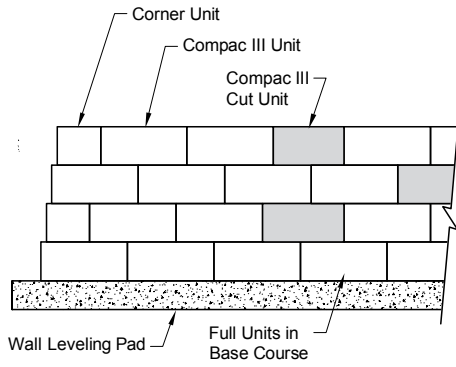

KEYSTONE COMPAC® STRAIGHT

The information contained herein has been compiled by Keystone Retaining Wall Systems® LLC and to the best of our knowledge, accurately represents the Keystone product used in the applications which are illustrated. Final determination of the suitability for the use contemplated and its manner of use are the sole responsibility of the user. Design and analysis shall be performed by a qualified engineer.

90° Outside Corner: Installation Details

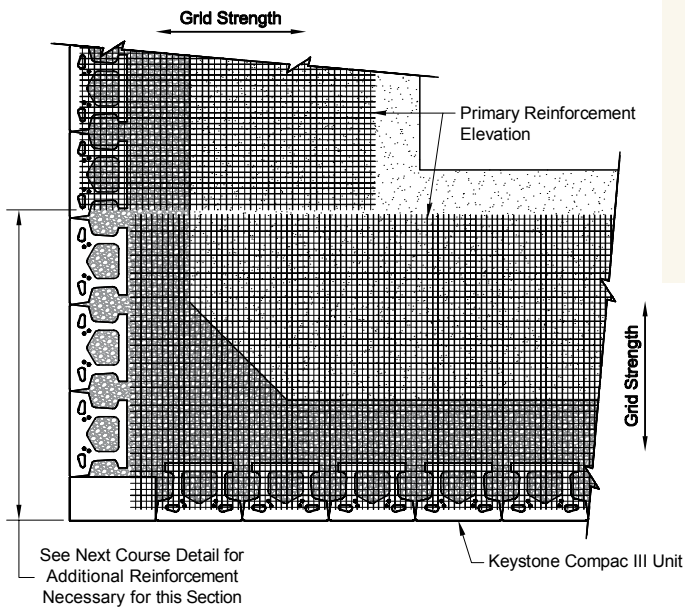

**C:5 - TYPICAL GEOGRID OUTSIDE CORNER
INSTALLATION (PRIMARY ELEVATION)**

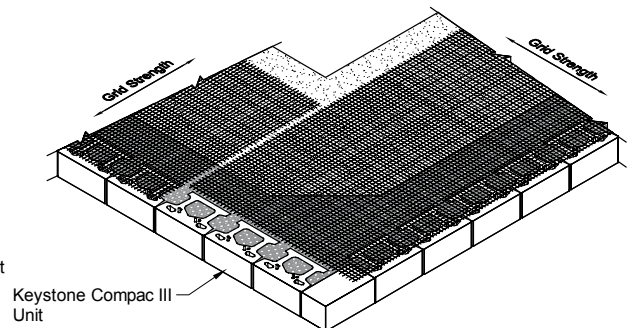
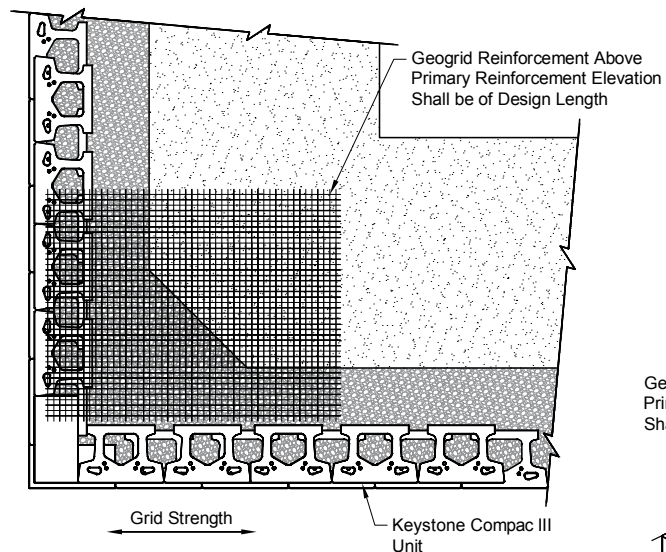
NOTES:

- The geogrid strength direction must be perpendicular to each wall.
- Geogrid layers cannot be placed immediately on top of each other. A minimum of 2-3-inches of soil must be placed between geogrid layers placed on the same course.
- Using the procedures outlined in drawings C:5 and C:6 will achieve the proper placement of geogrid in outside 90° corners.

**C:6 - TYPICAL GEOGRID OUTSIDE CORNER
INSTALLATION (SECONDARY ELEVATION)**

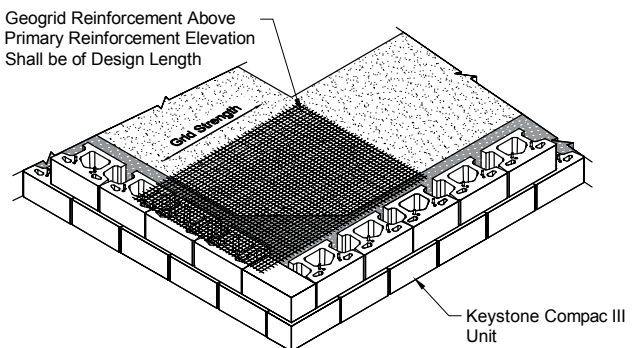
NOTES:

- Place the next course of units over the primary reinforcement elevation course.
- Place and properly compact the needed core/drainage/reinforced fill.
- Place the piece of reinforcement shown in drawing C:6 that is "missing" in drawing C:5.
- Make sure the geogrid strength direction is perpendicular to the wall face and the geogrid is not placed in the adjacent wall.

Geogrid Reinforcement Above
Primary Reinforcement Elevation
Shall be of Design Length

Note:

Unit drainage fill and reinforced backfill between Layers of geogrid not shown here for illustrative purposes.

90° Inside Corner: Installation Details

The construction of inside corners is relatively simple because no corner units are required. Construction of inside 90° corners should be accomplished by utilizing the interlocking method as shown below. Small side-to-side adjustments to the running bond pattern will be necessary as the wall rises vertically.

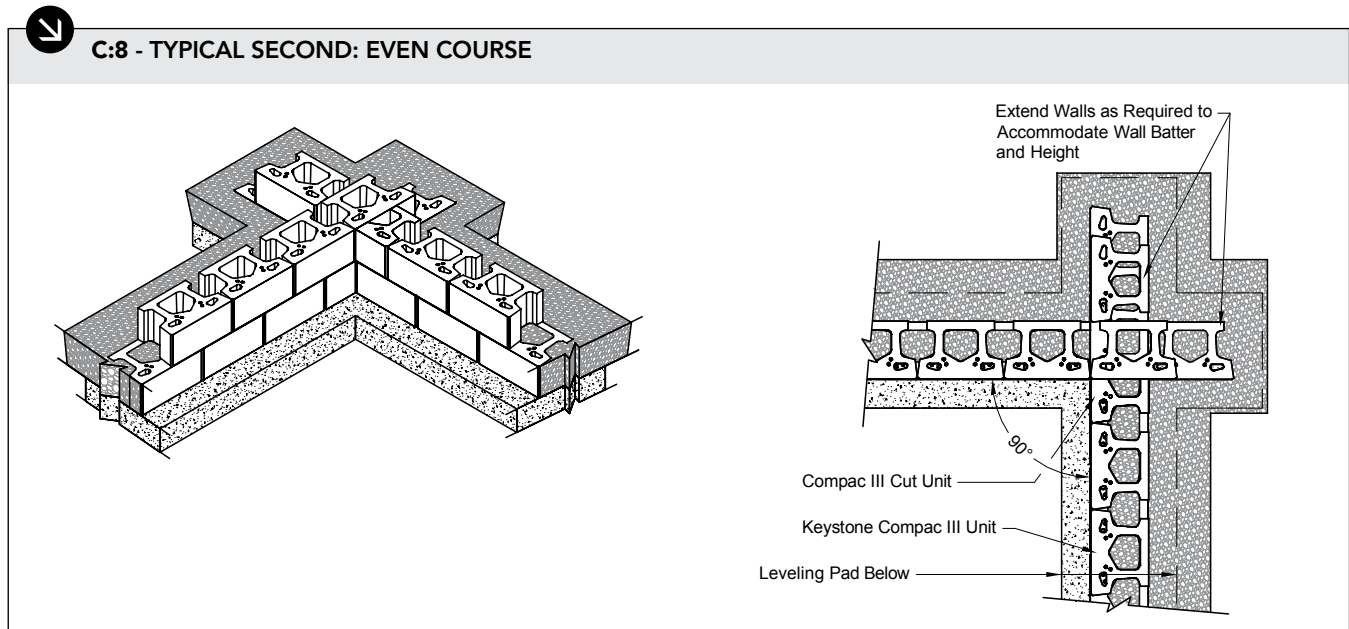
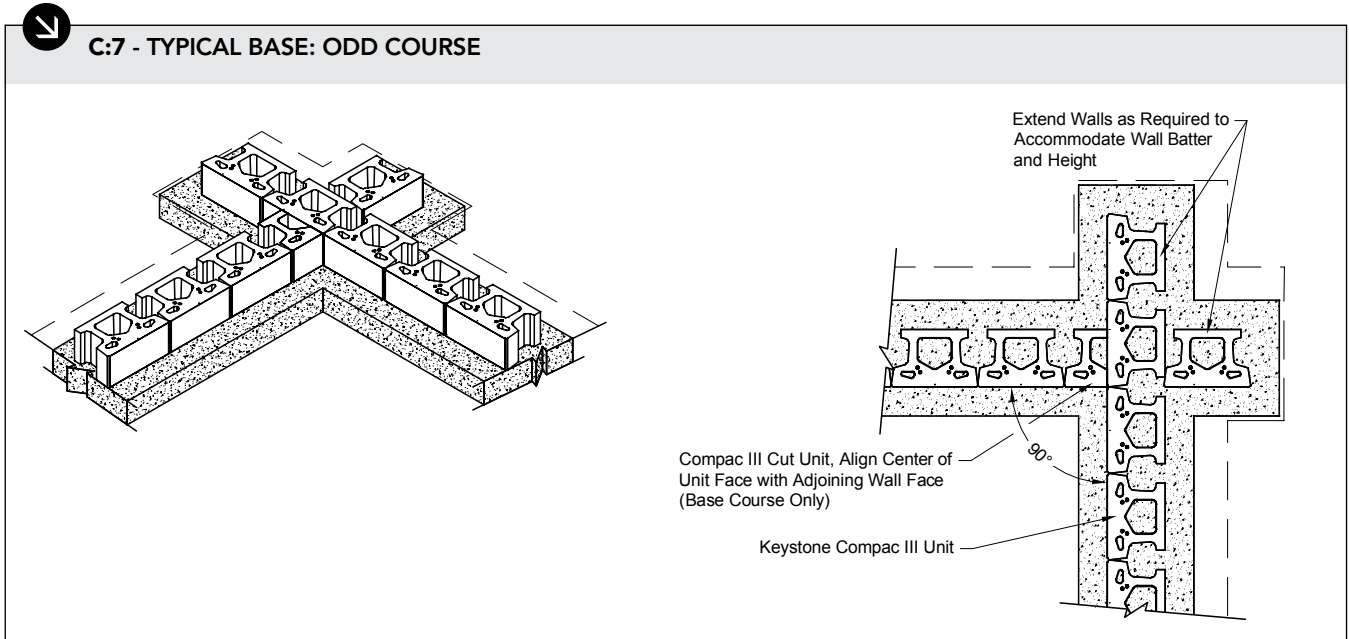

NOTES:

- Due to corner perpendicular wall setback per course, to maintain running bond course alignment, cut the adjoining unit to the perpendicular wall face as needed in both directions for proper wall joint alignment. Glue in place. This detail is similar for Keystone Standard units.
- Alternate cut units on odd and even courses.
- Placement of cut wall block less than 6-inches wide is not allowed. For example, assume the "gap" to be covered is 5-inches. Remove the adjacent unit and measure the gap distance of 23-inches (5-inches + 18-inches = 23-inches). Cut two units, $23/2 = 11.5$ inches wide, and place them in the wall.

The information contained herein has been compiled by Keystone Retaining Wall Systems® LLC and to the best of our knowledge, accurately represents the Keystone product used in the applications which are illustrated. Final determination of the suitability for the use contemplated and its manner of use are the sole responsibility of the user. Design and analysis shall be performed by a qualified engineer.

90° Inside Corner: Installation Details

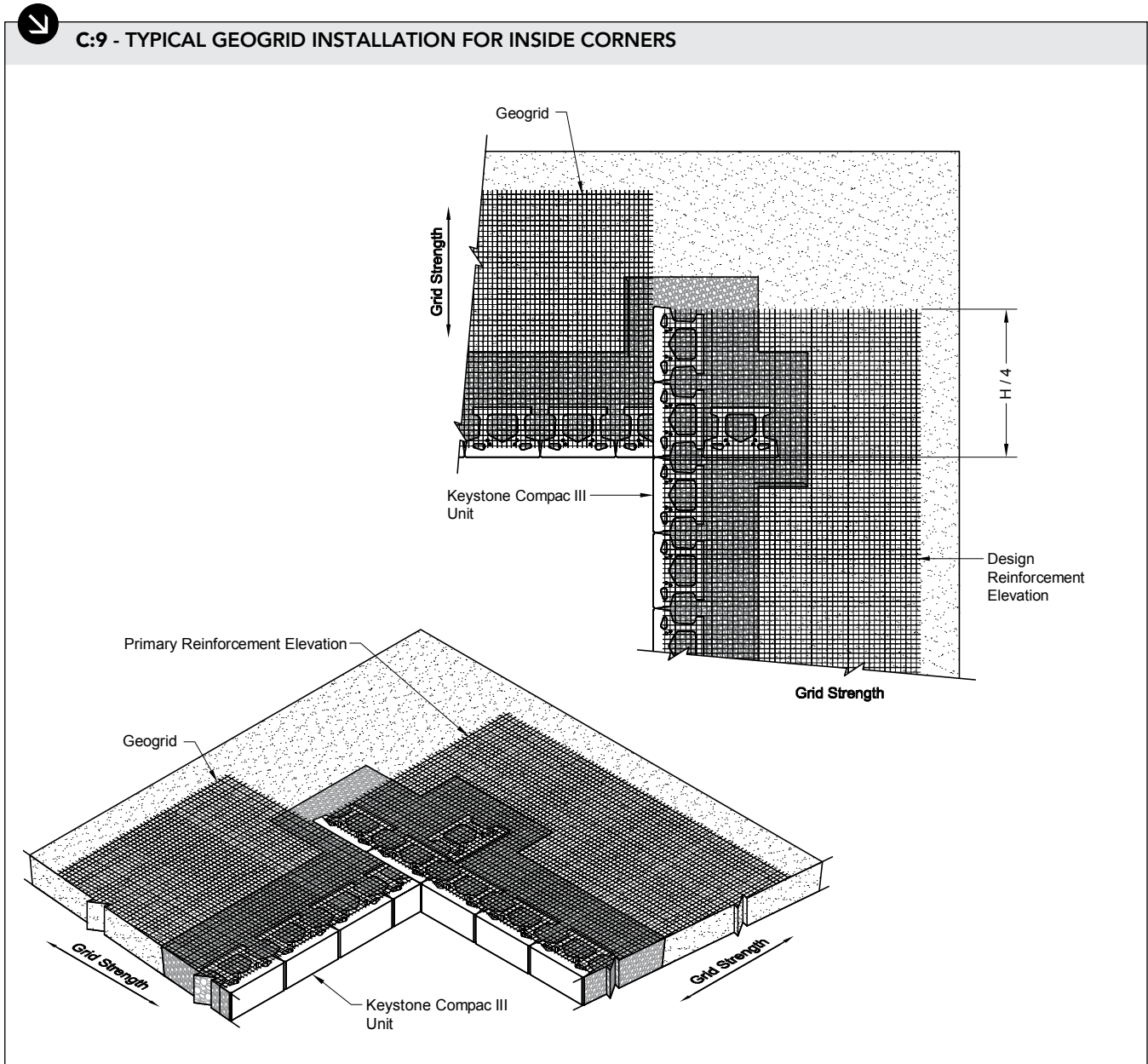
**NOTES:**

- Drainage zone and backfill materials should be placed and compacted up to the geogrid elevation prior to geogrid installation.
- Measure, cut and orient the geogrid, as per the engineer's design, in the correct strength direction.
- Place the geogrid over the Keystone unit within 1-inch of the front block face, then place next course units over grid to hold grid in place. Next, tension the geogrid by pulling it back away from the wall. Place a stake through the geogrid at the back to tension the geogrid in place.
- Extend geogrid layer into the corner from the continuous woven course side equal to $H/4$ (25%) of the total wall height.

The information contained herein has been compiled by Keystone Retaining Wall Systems® LLC and to the best of our knowledge, accurately represents the Keystone product used in the applications which are illustrated. Final determination of the suitability for the use contemplated and its manner of use are the sole responsibility of the user. Design and analysis shall be performed by a qualified engineer.

90° Inside Corner: Installation Details

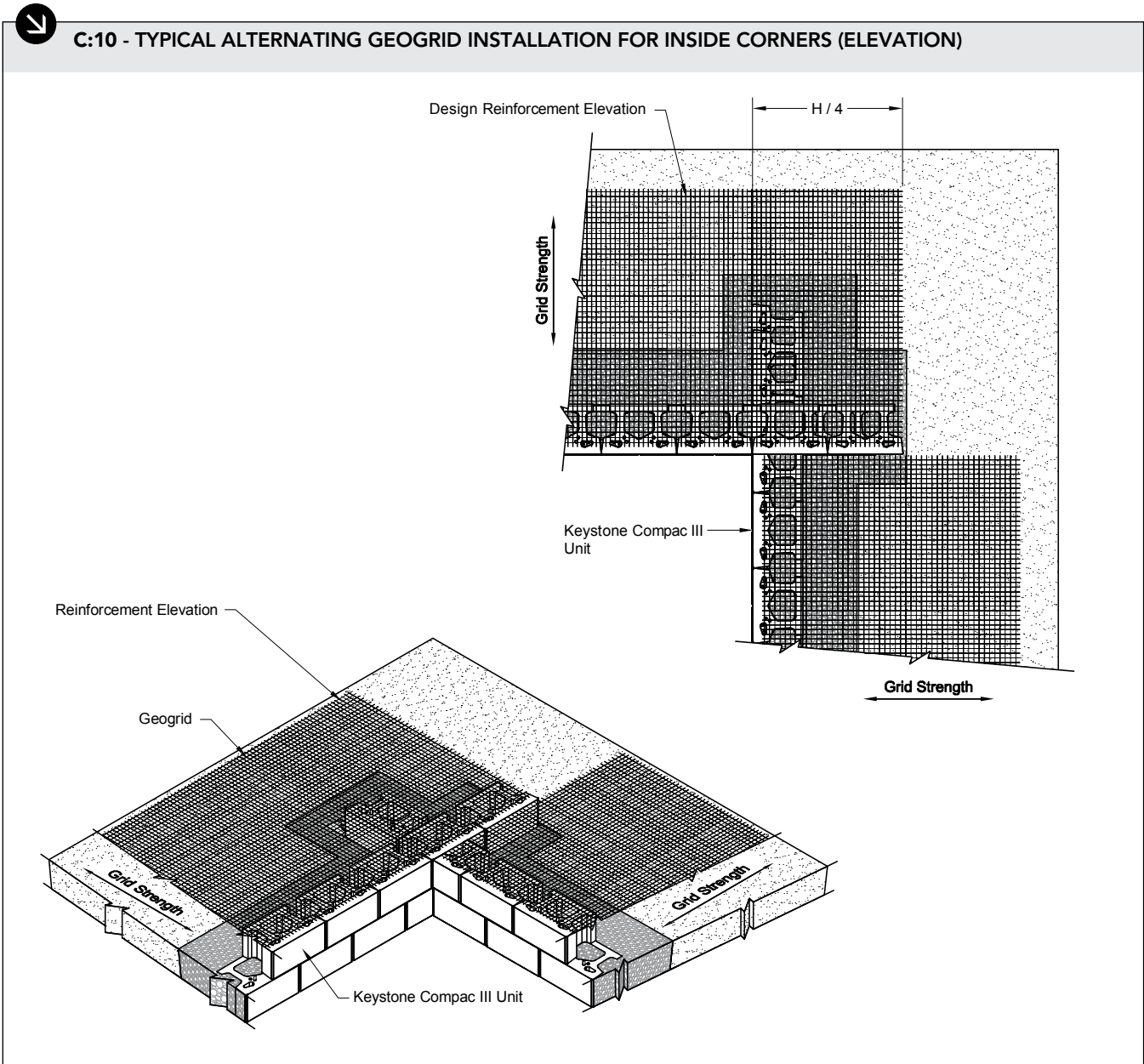

NOTES:

- Proceed with placement of additional Keystone units and unit drainage fill. Start backfilling nearest the Keystone units and then move away from the wall placing backfill materials over the geogrid.
- Compact the backfill materials in 8-inch lifts up to the next reinforcement elevation.
- Extend geogrid layer into the corner from the continuous woven course side equal to H/4 (25%) of the total wall height.
- Alternate placement of reinforcement extension on specified reinforcement elevations.

The information contained herein has been compiled by Keystone Retaining Wall Systems® LLC and to the best of our knowledge, accurately represents the Keystone product used in the applications which are illustrated. Final determination of the suitability for the use contemplated and its manner of use are the sole responsibility of the user. Design and analysis shall be performed by a qualified engineer.

Concave (Inside) Curves: Installation Details

Inside curves for moderately tall Keystone walls are more difficult to construct than a straight wall due to the complex geometry resulting from a battered wall face in a curve. Inside curves allow good access for compaction and the wall face units tend to support each other like an arch when the soil strain associated with the active earth pressure condition develops. As the wall gets taller, inside curves will result in the top of the wall becoming longer than the base. For wall systems to maintain the desired running bond configuration, gaps between units tend to form.

The following is an outline to a process of constructing inside curves in taller walls. See the illustrations below.

1. Units can be moved laterally to remove gapping. Eventually, cutting partial units will be necessary to get the coursing back on the running bond pattern.
2. The minimum inside radius at the base of the wall course should not be less than 6 feet.

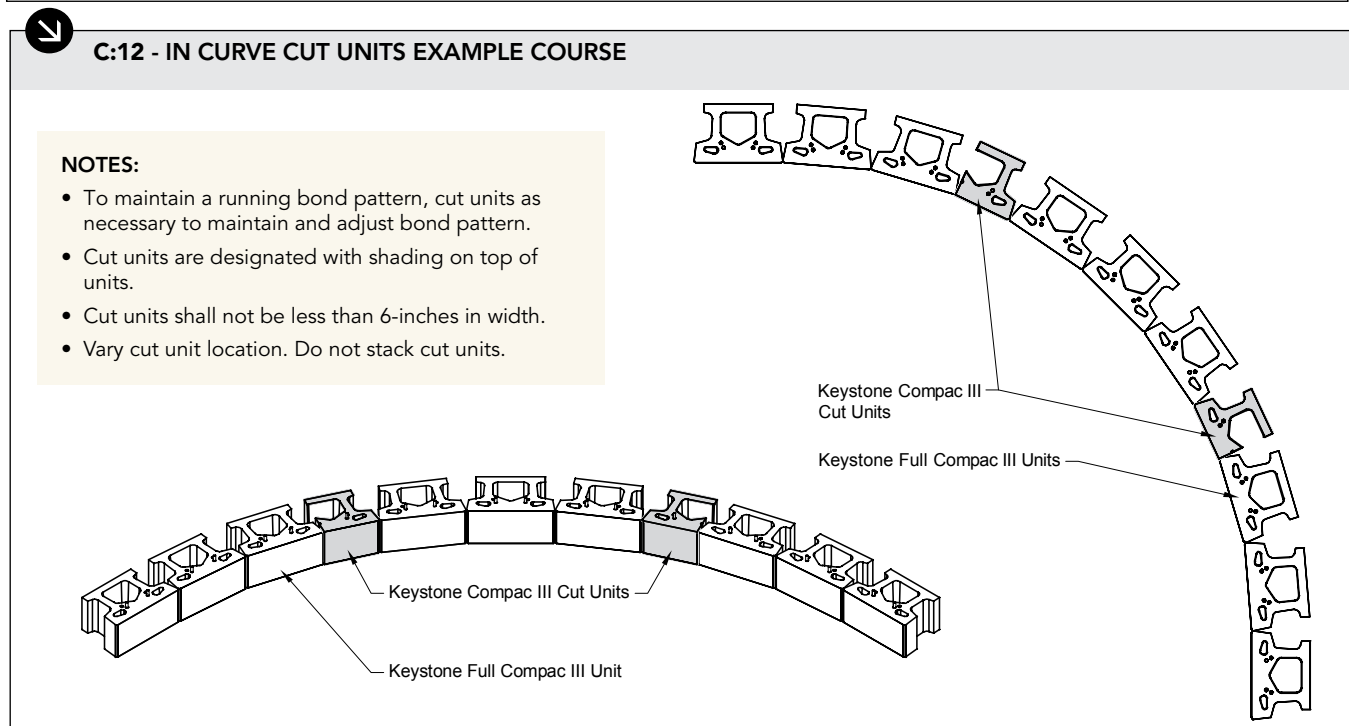
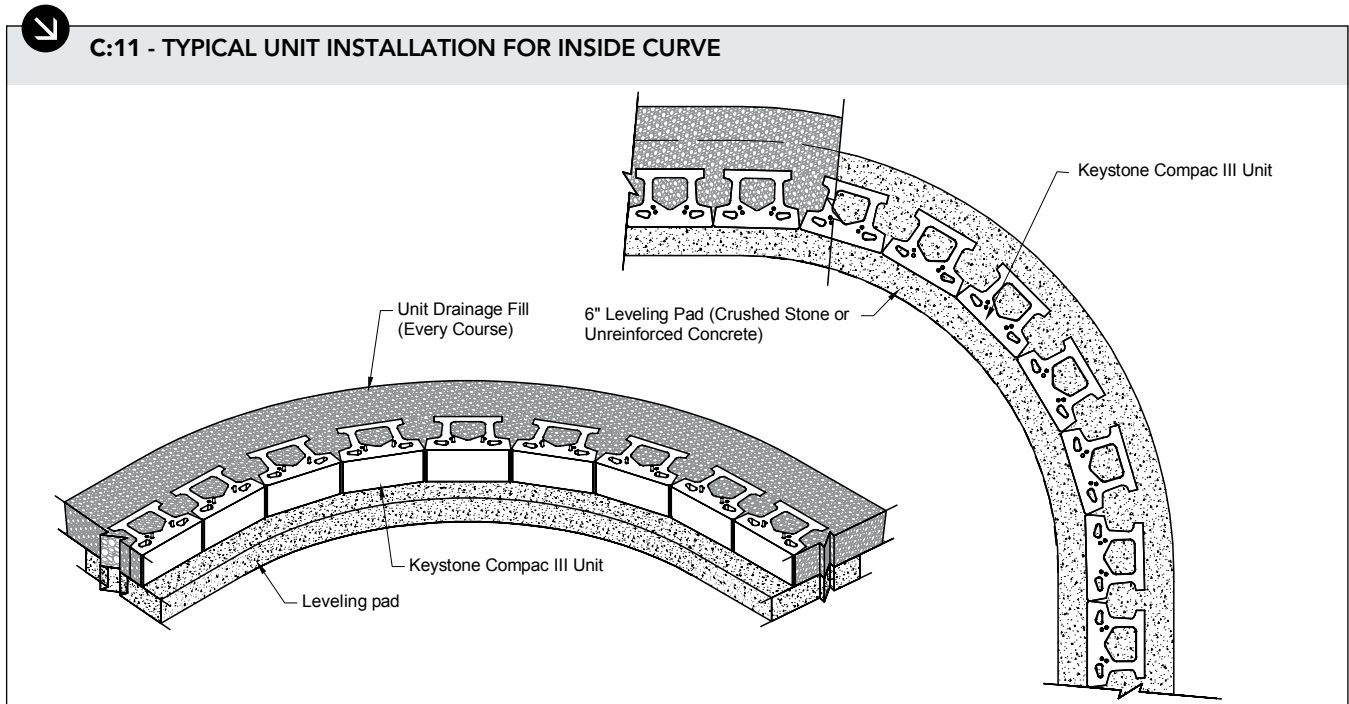

The information contained herein has been compiled by Keystone Retaining Wall Systems® LLC and to the best of our knowledge, accurately represents the Keystone product used in the applications which are illustrated. Final determination of the suitability for the use contemplated and its manner of use are the sole responsibility of the user. Design and analysis shall be performed by a qualified engineer.

Concave (Inside) Curves: Installation Details



C:13 - INSIDE CURVE GEOGRID INSTALLATION (PRIMARY ELEVATION)

Place Additional Geogrid Reinforcement on Next Block course Immediately Above the Specified Reinforcement Elevation (Shown on this Course for Illustrative Purposes)

When the Gaps Between Adjacent Geogrid Exceed 20°, Place Additional Geogrid Reinforcement on the Next Block Course Immediately Above the Primary Reinforcement Elevation

Primary Reinforcement Elevation

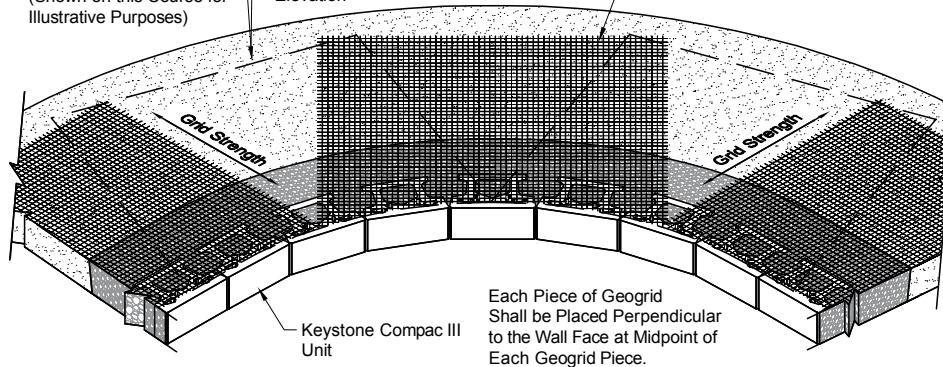

NOTES:

- Drainage zone and backfill materials should be placed and compacted up to the primary geogrid elevation prior to geogrid installation.
- Measure, cut and orient the geogrid, as per the engineer's design, in the correct strength direction.
- Place the geogrid over the Keystone units within 1-inch of the front block face, then place next course units over grid to hold grid in place. Next, tension the geogrid by pulling it back away from the wall. Place a stake through the geogrid at the back to tension the geogrid in place.



C:14 - INSIDE CURVE TYPICAL GEOGRID INSTALLATION (SECONDARY ELEVATION)

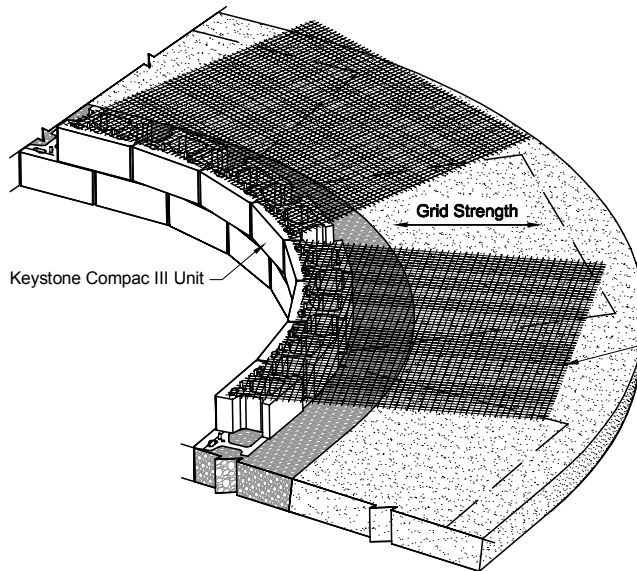

Additional Geogrid Reinforcement on Next Block Course Immediately Above the Primary Reinforcement Elevation Center Additional Geogrid on Opening Place Perpendicular to Wall Face

NOTES:

- Proceed with placement of additional Keystone units and unit drainage fill. Start backfilling nearest the Keystone units and then move away from the wall placing backfill materials over the geogrid.
- Compact the backfill materials in 8-inch lifts up to the next reinforcement elevation.
- If the radius of the wall creates a gap between adjacent primary elevation geogrid layers (see Figure C:13, above) of greater than 20 degrees, mark the wall units in the center of the gap, then place an additional secondary elevation on the course above the primary elevation geogrid, with the middle of the secondary elevation geogrid centered on the mark made in the center of the gapped geogrid below.
- The use of 12-foot wide rolls of geogrid will not be possible in walls with anything tighter than a gradual inside radius curve. Very tight inside radius curves may even require cutting the width of the roll to maintain the geogrid being as perpendicular as possible to the wall units.

The information contained herein has been compiled by Keystone Retaining Wall Systems® LLC and to the best of our knowledge, accurately represents the Keystone product used in the applications which are illustrated. Final determination of the suitability for the use contemplated and its manner of use are the sole responsibility of the user. Design and analysis shall be performed by a qualified engineer.

Convex (Outside) Curves: Installation Details

Keystone units can be easily integrated with multiple curves within the same wall. However, convex curves require attention to details during construction. Every wall system has a minimum radius that can be built before the tails of the units come into contact with each other. This minimum radius is unique to the shape of each individual block system. In convex curves, the tightest radius will always be the top course of the wall. This means that the radius at the base course of a convex curve wall will be larger than the desired radius at the top of the wall. Care should be taken when laying out a wall horizontal location in the field given these wall batter and radius relationships.

The minimum radius of an outside curve should not be less than 5-feet. When constructing an outside curve, we recommend performing the following steps to maintain running bond configuration. It is recommended to construct the wall into the curve, maintaining a running bond pattern in the straight sections of the wall on either side of the curve. (See Figure C:15, below.) Due to the unit setback, the radius change in a curved wall will cause the units to migrate off from running bond. When this occurs, it will be necessary to cut a block to maintain running bond; cut unit width shall be no smaller than 6-inches. Use exterior grade concrete adhesive to secure the partial unit. When coming out of the radius, do not stack cut units. Cutting of another block may be required to maintain a more precise running bond on the straight wall extending away from the curve.

C:15 - OUTSIDE CURVE RUNNING BOND

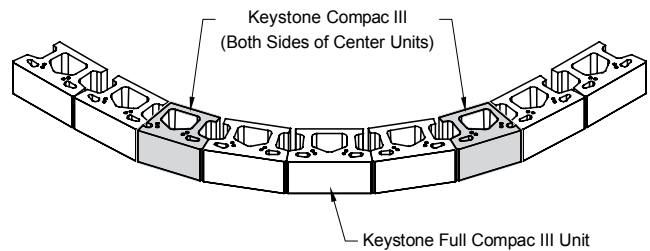
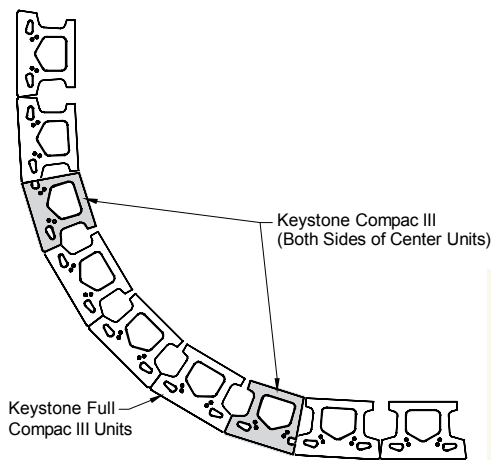

NOTES:

- Full uncut units to be used for the base course and as indicated in the details.
- Verify actual cut widths for each course as wall is constructed.
- Cut units shall not be less than 6-inches in width.
- Do not stack cut units.

C:16 - OUTSIDE CURVE ADDITIONAL DRAINAGE FILL

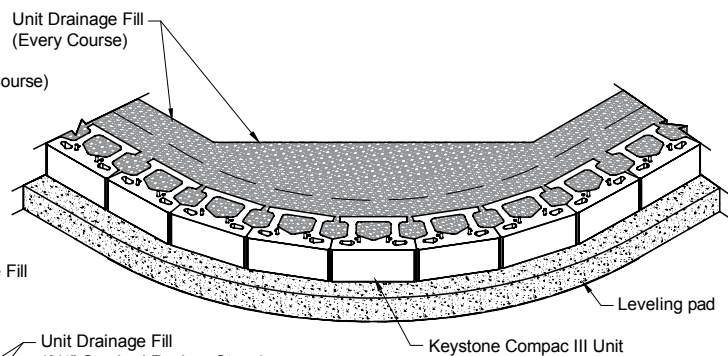
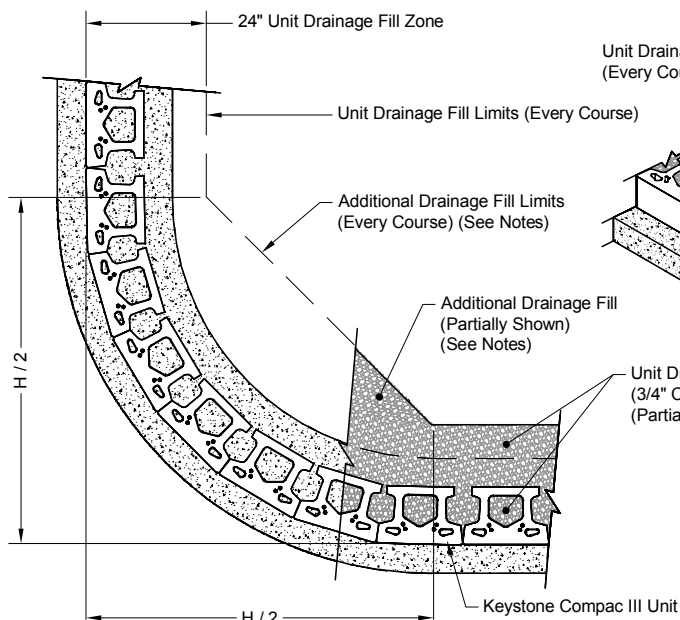

NOTE:

- Place additional drainage fill at outside wall curves to extend back from wall face each way a distance of the wall height / 2, (H/2).

The information contained herein has been compiled by Keystone Retaining Wall Systems® LLC and to the best of our knowledge, accurately represents the Keystone product used in the applications which are illustrated. Final determination of the suitability for the use contemplated and its manner of use are the sole responsibility of the user. Design and analysis shall be performed by a qualified engineer.

Convex (Outside) Curves: Installation Details

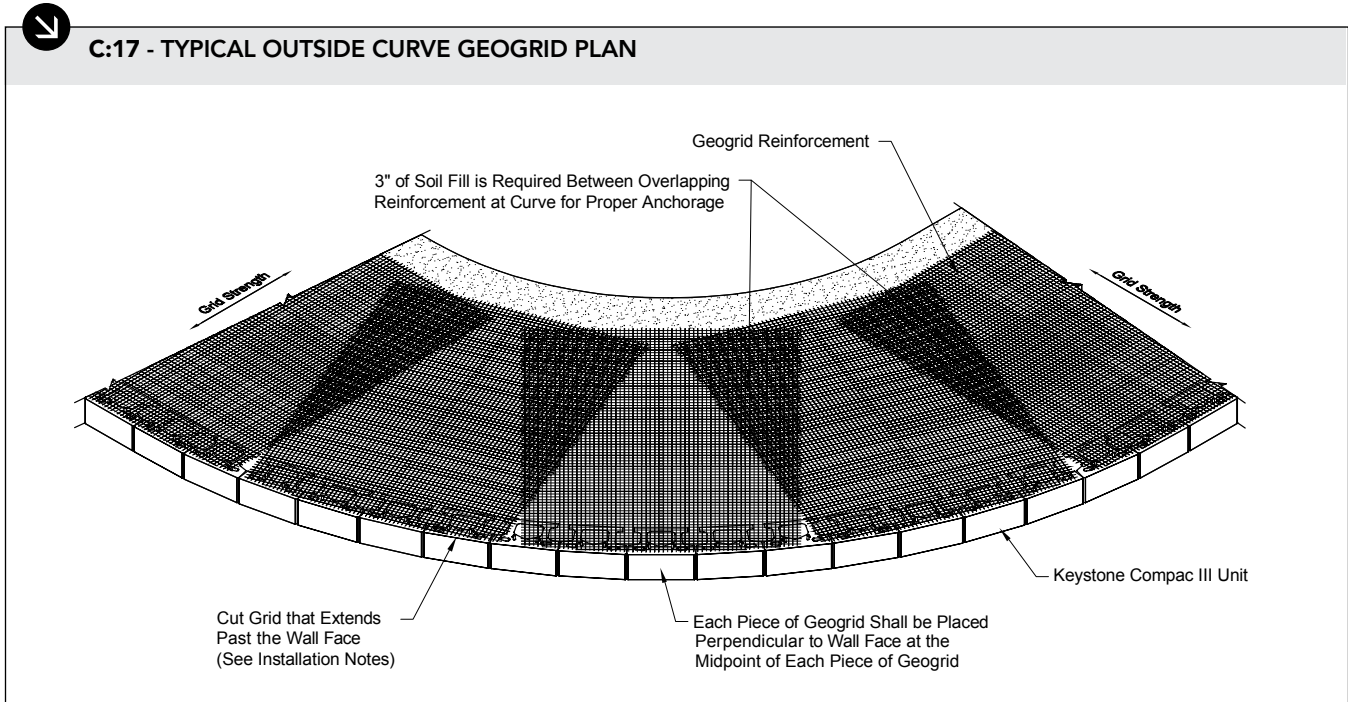

NOTES:

- Drainage zone and backfill materials should be placed and compacted up to the geogrid elevation prior to geogrid being installed at design elevation. Place geogrid in strength direction, perpendicular to wall face
- Measure, cut and orient the geogrid, as per the engineer's design, in the correct strength direction.
- Place the geogrid over the Keystone units within 1-inch of the front block face, then place next course units over grid to hold grid in place. Next, tension the geogrid by pulling it back away from the wall. Place a stake through the geogrid at the back to tension the geogrid in place.
- Proceed with placement of additional Keystone units, then drainage zone and backfill material. Starting at the wall and moving away from the wall, place the drainage zone and backfill materials over the geogrid to hold the geogrid in place under tension.
- Compact the backfill materials in 8-inch lifts up to the next reinforcement elevation.
- Cut grid that extends beyond curved wall face 1-inch back from wall face. The minimum geogrid length must match design length.
- Where geogrid tail overlap naturally occurs, place 3-inches of rock or soil between the overlapping layers.



The information contained herein has been compiled by Keystone Retaining Wall Systems® LLC and to the best of our knowledge, accurately represents the Keystone product used in the applications which are illustrated. Final determination of the suitability for the use contemplated and its manner of use are the sole responsibility of the user. Design and analysis shall be performed by a qualified engineer.



KEYSTONE COMPAC® STRAIGHT

SECTION D

WALL FINISHING OPTIONS

A wall is not complete without the perfect finishing touch. The flexibility of the Keystone units creates a variety of wall finishing options. The most common wall finish is to cap the wall with a Keystone cap. Cap options vary by region so check with your local Keystone producer for availability in your area. Keystone units can also be capped with a variety of decorative precast concrete products, or even cast-in-place concrete copings. This section outlines the construction techniques and details for installing Keystone caps.

Cap Units: Introduction

A Keystone retaining wall is not complete until it is finished with the right cap. Local manufacturers offer a selection of cap designs, available in various combinations of facial finishes. The following information will clearly explain the uses of these units and show a variety of finishing techniques. You may also opt to finish your wall with a precast decorative concrete finishing option. See your local manufacturer for details.

CAPPING UNITS

Universal Cap:

Finished on both front and back

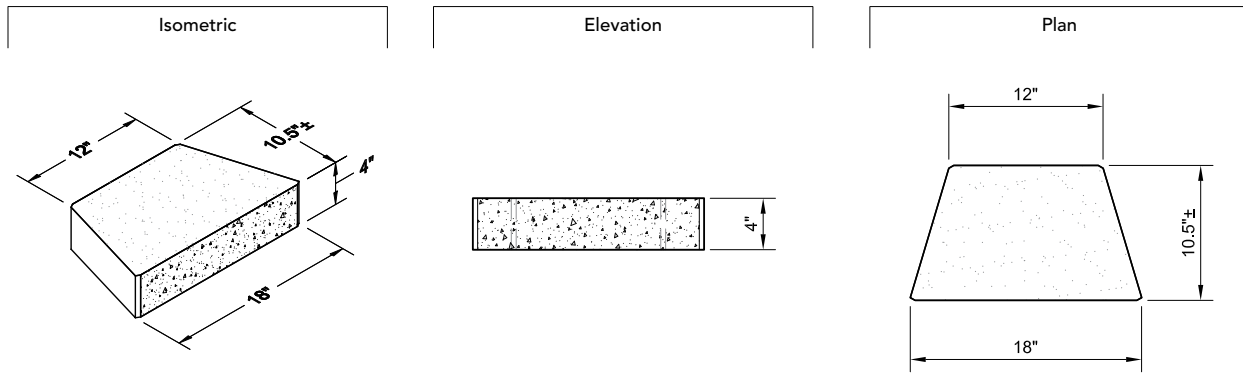

Straight-face:

Straight sided, finished on one side

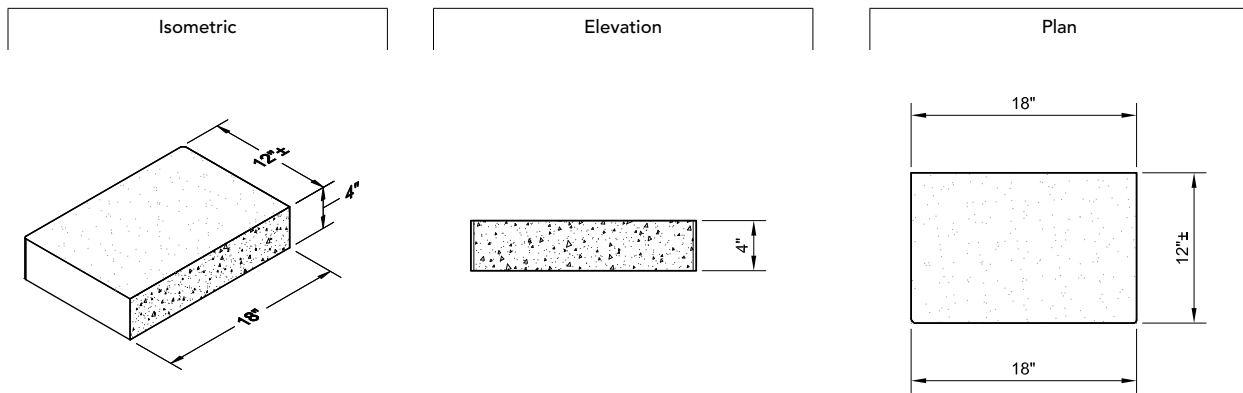

The information contained herein has been compiled by Keystone Retaining Wall Systems® LLC and to the best of our knowledge, accurately represents the Keystone product used in the applications which are illustrated. Final determination of the suitability for the use contemplated and its manner of use are the sole responsibility of the user. Design and analysis shall be performed by a qualified engineer.

Cap Units: Introduction



D:1 - CAP CONNECTION

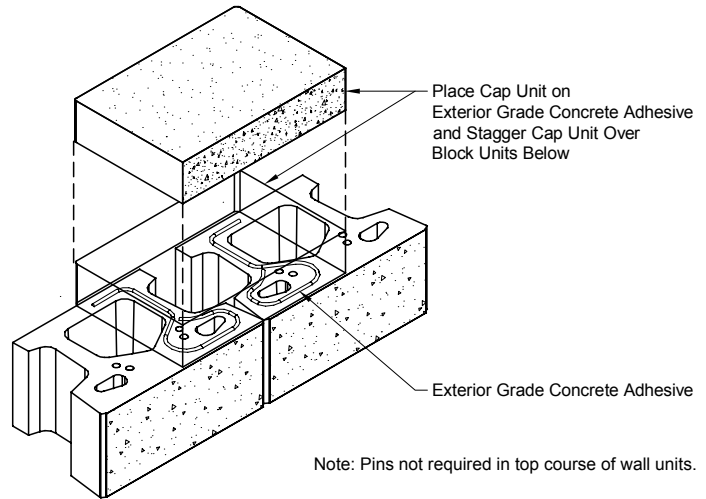
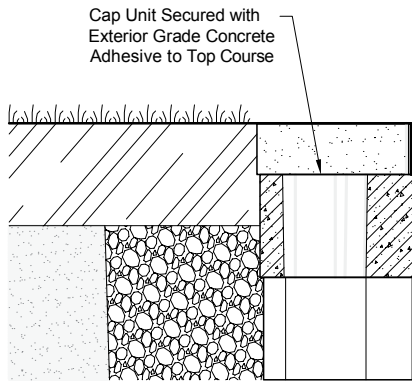

The information contained herein has been compiled by Keystone Retaining Wall Systems® LLC and to the best of our knowledge, accurately represents the Keystone product used in the applications which are illustrated. Final determination of the suitability for the use contemplated and its manner of use are the sole responsibility of the user. Design and analysis shall be performed by a qualified engineer.

Capping: Straight Walls

Straight Wall Capping

The size of each Keystone unit makes this system very adaptable to grade changes. The top of a Keystone wall can be constructed with level top of wall grade or with step-downs in the top of the wall. As the wall cap units step up and down grades, an additional installation procedure is required to firmly fix some cap units in position. 4-inch cap units can be double-stacked (*see Figure D:3, below*). Pins are not required in the top course of units. The caps should be attached using an exterior grade concrete adhesive. Refer to manufacturer's instructions for complete details. Apply the adhesive to areas where the units make contact.

Determine the desired cap horizontal location with respect to the top wall course. It is typical to have about a one-inch "overhang" of the cap in front of the course of wall units below. With the use of a string line, the cap units can be placed in a straight line. Sweep the lower units clean and make sure the units are dry; use an exterior grade concrete adhesive on the top surface of the last course before applying cap units. (*See Figure D:1, page 47.*) The following illustrations demonstrate common uses of the Keystone cap units.

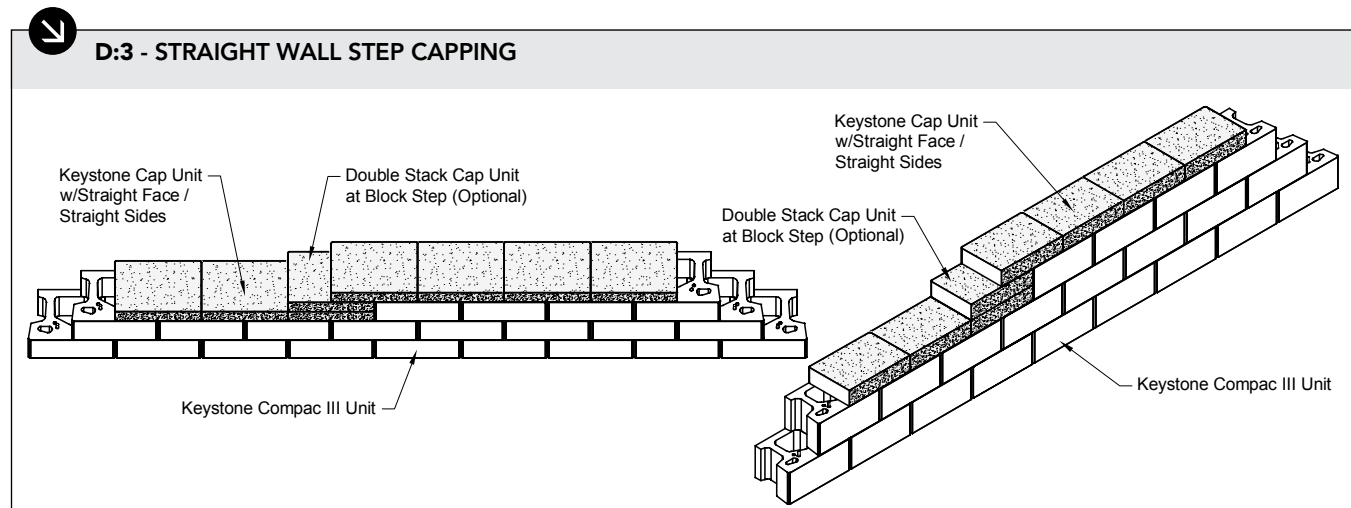
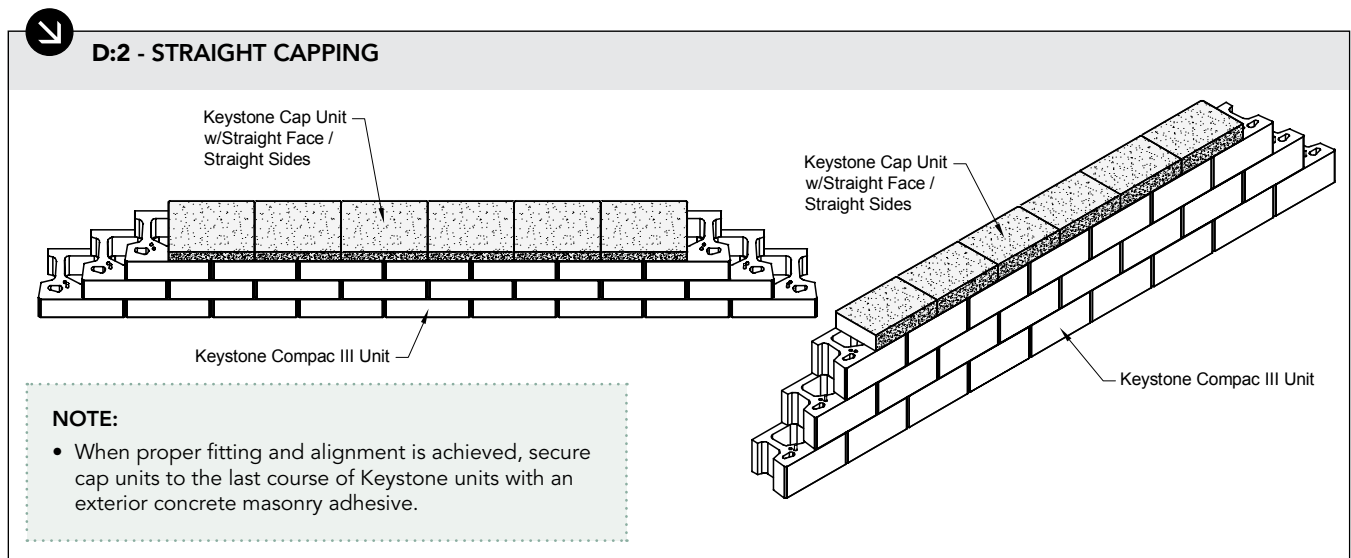

NOTES:

- As top-of-wall grade changes and wall block units step up or down, additional cap units can be placed at the point of wall stepping. Place 2 cap units stacked on top of each other next to the last wall block unit in each course. Overlap the upper course cap unit on top of the double-stacked cap units in the running bond pattern.
- When proper fitting and alignment is achieved, secure the double-stacked caps together and cap units to the last course of Keystone units with an exterior concrete masonry adhesive.

The information contained herein has been compiled by Keystone Retaining Wall Systems® LLC and to the best of our knowledge, accurately represents the Keystone product used in the applications which are illustrated. Final determination of the suitability for the use contemplated and its manner of use are the sole responsibility of the user. Design and analysis shall be performed by a qualified engineer.

Capping: Curved Walls

Like other Keystone units, all cap units can be used interchangeably. In any given installation, if binding or gapping occurs between units, the units can be modified to fit using a concrete saw. Make sure to wear proper PPE equipment when splitting or cutting.

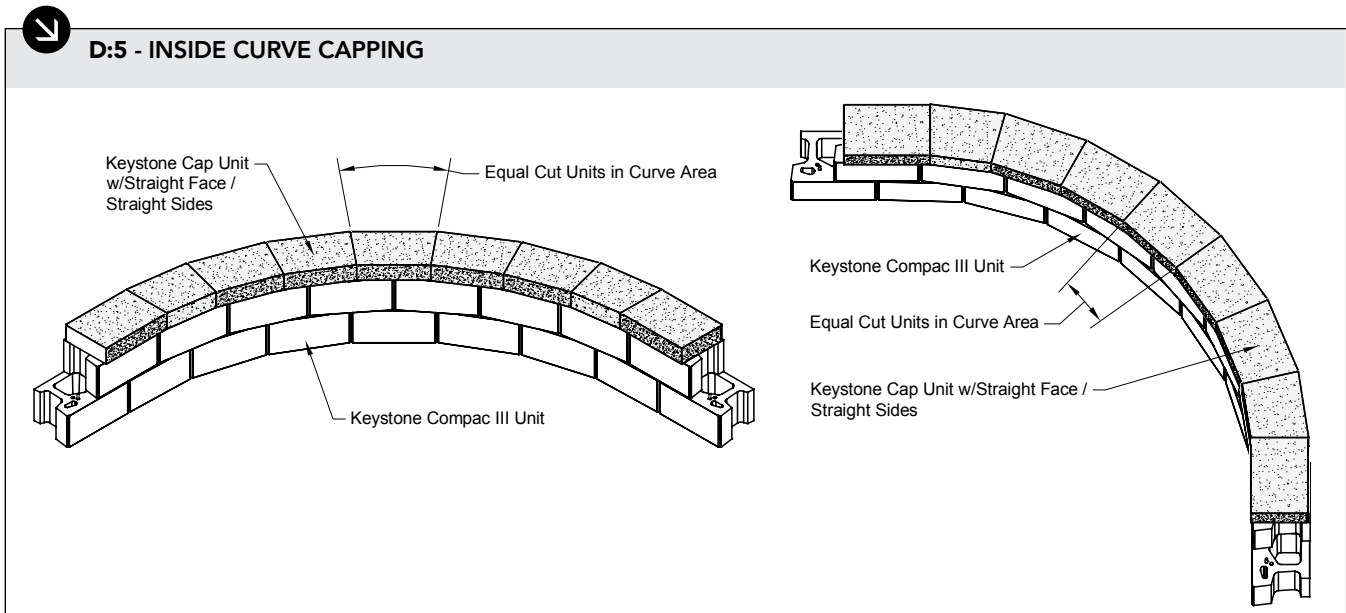
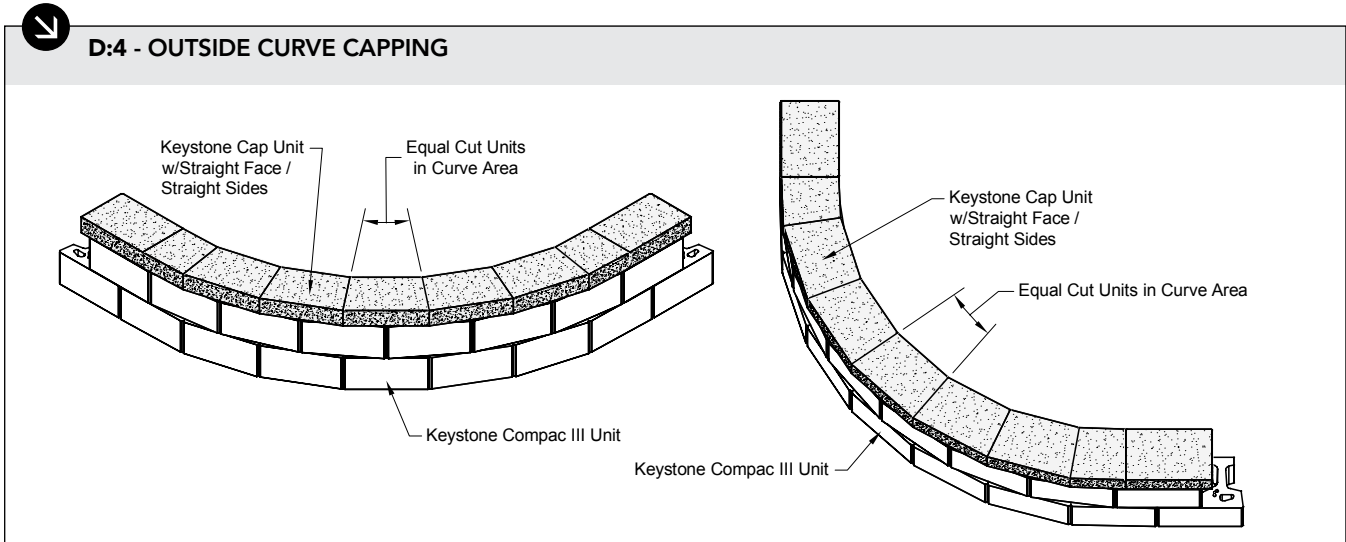

NOTES:

- If no gapping between cap units is desired, some cutting of the cap units may be required.
- When proper fitting and alignment is achieved, secure cap units to the last course of Keystone units with an exterior grade concrete masonry adhesive.

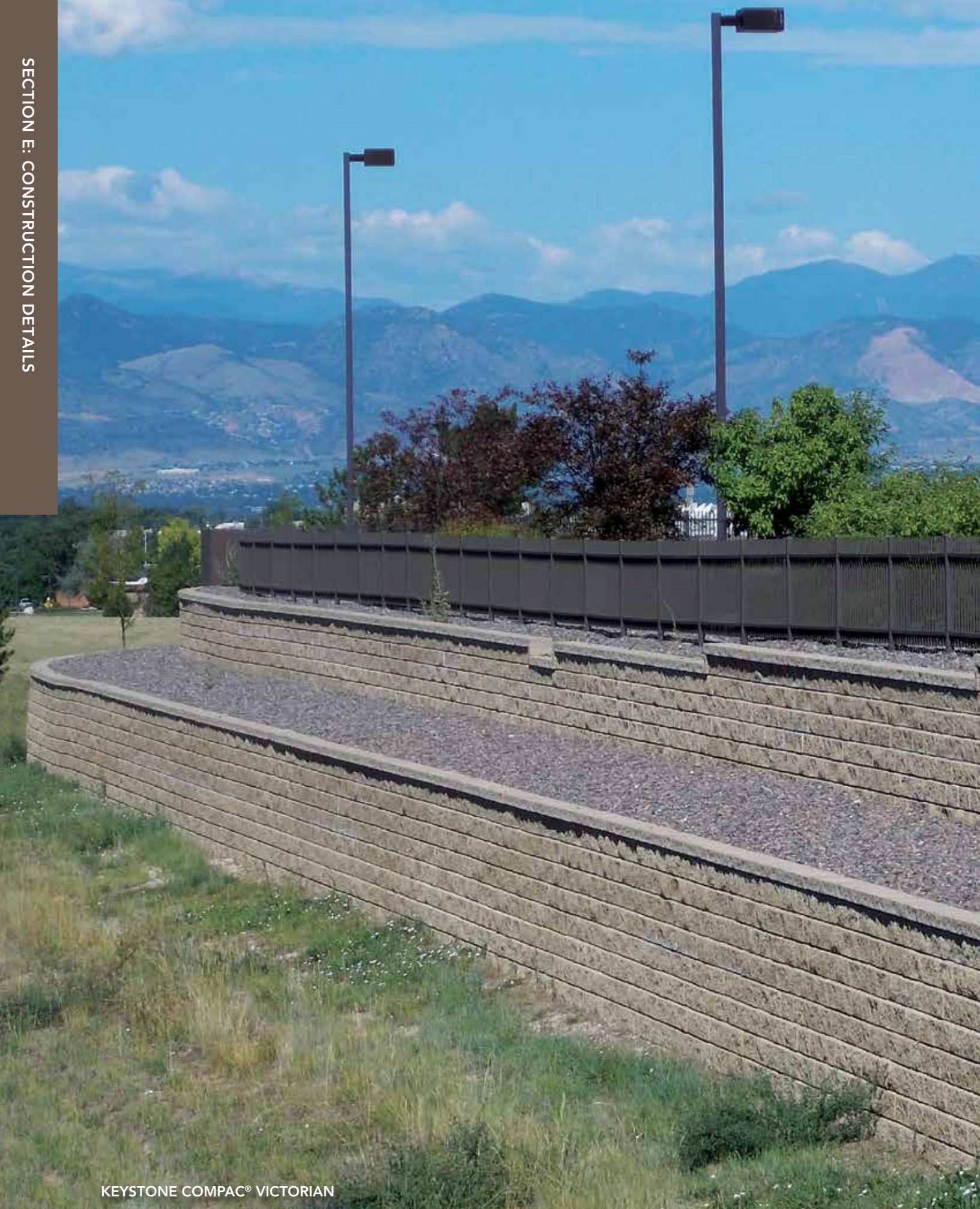

KEYSTONE COMPAC® VICTORIAN

SECTION E

COMMON WALL CONSTRUCTION DETAILS

Since its inception in 1986, Keystone has been the segmental retaining wall design leader. This section covers a variety of the most common wall application details that may be confronted when constructing a Keystone wall. Some of the wall application details presented in this section have been developed specifically based on industry design standards. Other wall application details have been developed through our years of experience in the segmental retaining wall industry.

Items that are covered in this section:

- Water applications
- Utilities
- Retaining wall drainage
- Storm drain outlet
- Barriers
- Terraced wall applications
- Tree planting guidelines

Water Applications

When considering a water application for the Keystone wall system, the following areas need to be analyzed and designed to maintain structural integrity of the wall under normal, high-water conditions, and rapid draw-down conditions:

- Start by analyzing the wall under normal design criteria (i.e. wall height, base conditions, surcharge loads, soils data, reinforcement requirements, drainage, etc.)
- Determine the water level on the wall under normal and high-water conditions.
- Determine flow rate for streams, channels, etc.
- Determine degree of wave action: minor, major or boat wake.
- Determine the potential for flooding and inundation of the wall.
- The above conditions should be taken into account in the design of the wall.

Always contact a professional engineer to assist you in your water application design. At minimum, the wall reinforced zone soils, to 1 foot above the high-water elevation, should be a free-draining sand or gravel, wrapped in an appropriate filter fabric (see *Figure E:1, below*).

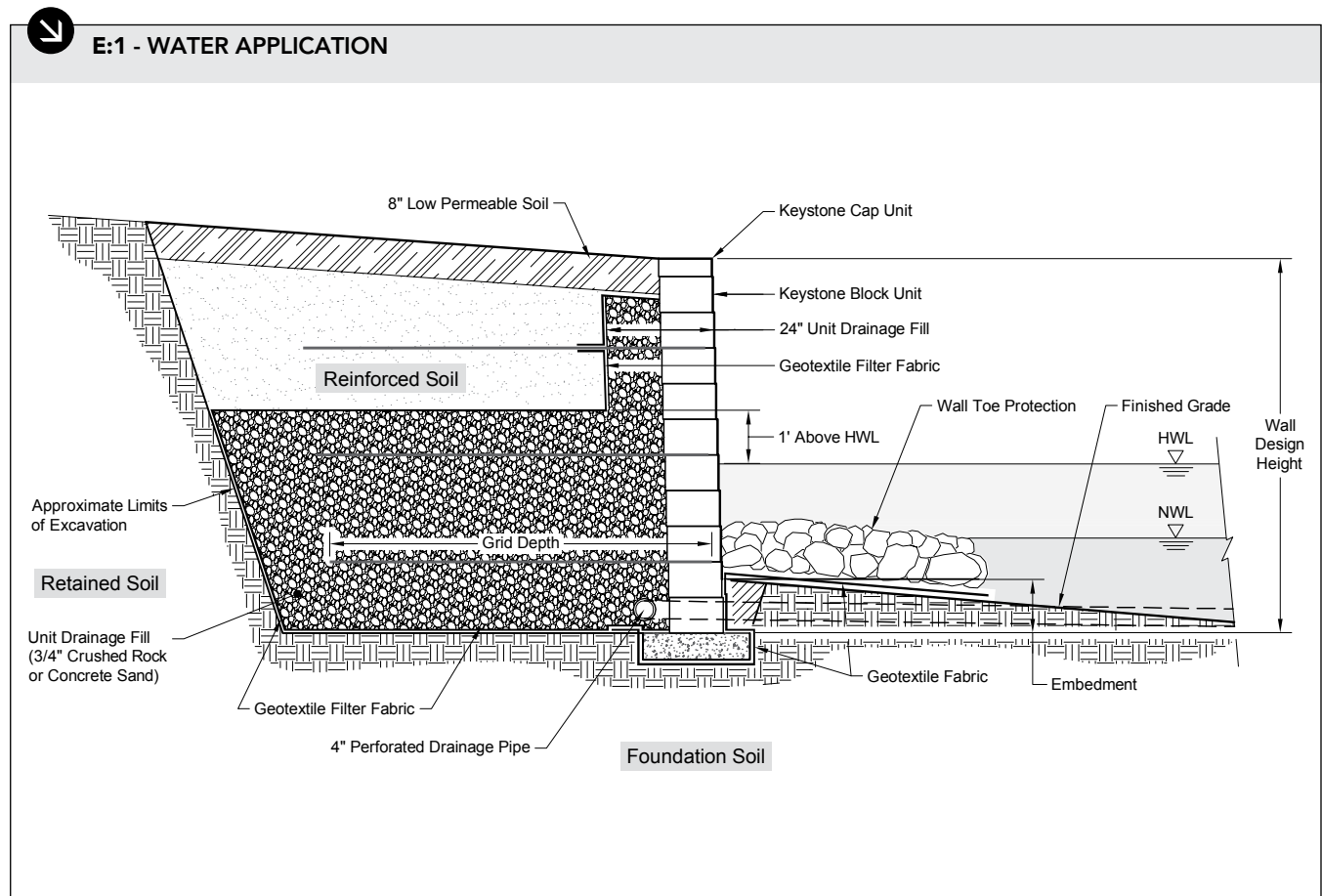

NOTE:

- Drains should be at the bottom of walls when possible. Utilize a raised drain location when bottom of wall drainage is not possible (see page 55).

Utilities

In general, the placement of utilities parallel to the wall, within the reinforced soil zone, **SHOULD BE AVOIDED**. Any maintenance to utilities in the reinforced soil zone will require deconstruction of the wall down to the pipe elevation so fully intact geogrid can be re-installed during backfilling. Also, coordination of the utility and wall contractors will be necessary during initial construction of the wall to avoid excavation through the geogrid.

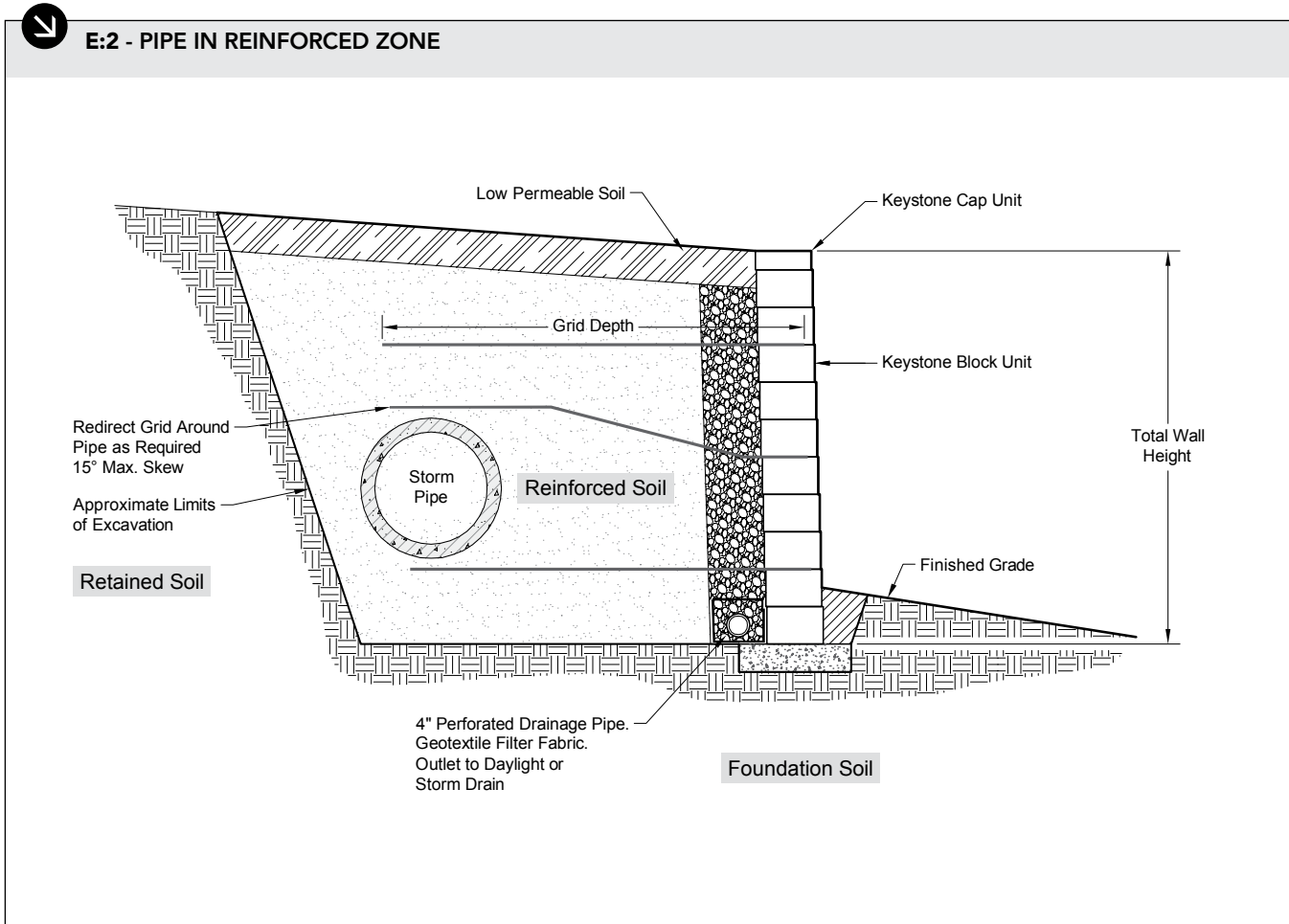

NOTE:

- Drain should be at bottom of wall when possible. Utilize raised drain location when bottom of wall drainage is not possible (see page 55).

Retaining Wall Drainage Options

Poor drainage is a leading cause of retaining wall performance issues. Hydrostatic pressure can accumulate behind a wall and add an increased load on the wall if drainage provisions are not installed or not adequate for the conditions. The Keystone system has superior drainage features. The techniques below should be considered if these project drainage issues are present.

- 1. Basic drainage/unit drainage fill:** Keystone's mortarless, interlocking system, with specific free-draining gravel drainage zone and corefill (see *Figure E:3, below*) allows proper drainage under most circumstances. Drain tiles should be routed to a storm drainage system or daylighted below or through the wall at every low point and/or 30 to 50-feet on center.
- 2. Surface run-off:** To reduce infiltration of surface drainage at the top of the retaining wall, place an 8-inch low permeable soil cap (i.e. clay) above the reinforced soil and drainage fill areas. The upper 8-inch low impermeable soil should be graded to flush with the top of cap elevation (see *Figure E:3, below*).
- 3. Drainage swale:** Some engineers and DOTs prefer a drainage swale at the top of the wall. To allow drainage down the swale, drainage swales can only be installed on walls that have one high point and the wall tapers down in elevation from that high point to the ends of the wall. SRWs tend to move slightly with time. To accommodate some movement, drainage swales should be constructed with relatively impermeable soil (clay) or asphalt. Drainage swales constructed with concrete tend to crack over time, either at the joints or elsewhere, or become separated from the expansion material between the swale and cap units. If a concrete swale must be installed, regular maintenance of any separations, cracks or joints should be anticipated (see *Figure E:4, page 55*).
- 4. Embankment flow:** When embankment ground water flow behind the wall is likely, place a drainage composite or chimney drain vertically against cut soil (consult with the design engineer of record for recommended coverage and installation instructions or drainage composite). The drainage composite or chimney drain should drain to an outflow pipe (i.e. drain tile) to remove water. Numerous cost-effective products are available to serve this purpose (see *Figure E:3, below*).
- 5. Ground water flow:** The effects of seasonally fluctuating ground water at the base of the retaining wall can be offset by placing a blanket drain along the base of the reinforced zone (see *Figure E:3, below*).

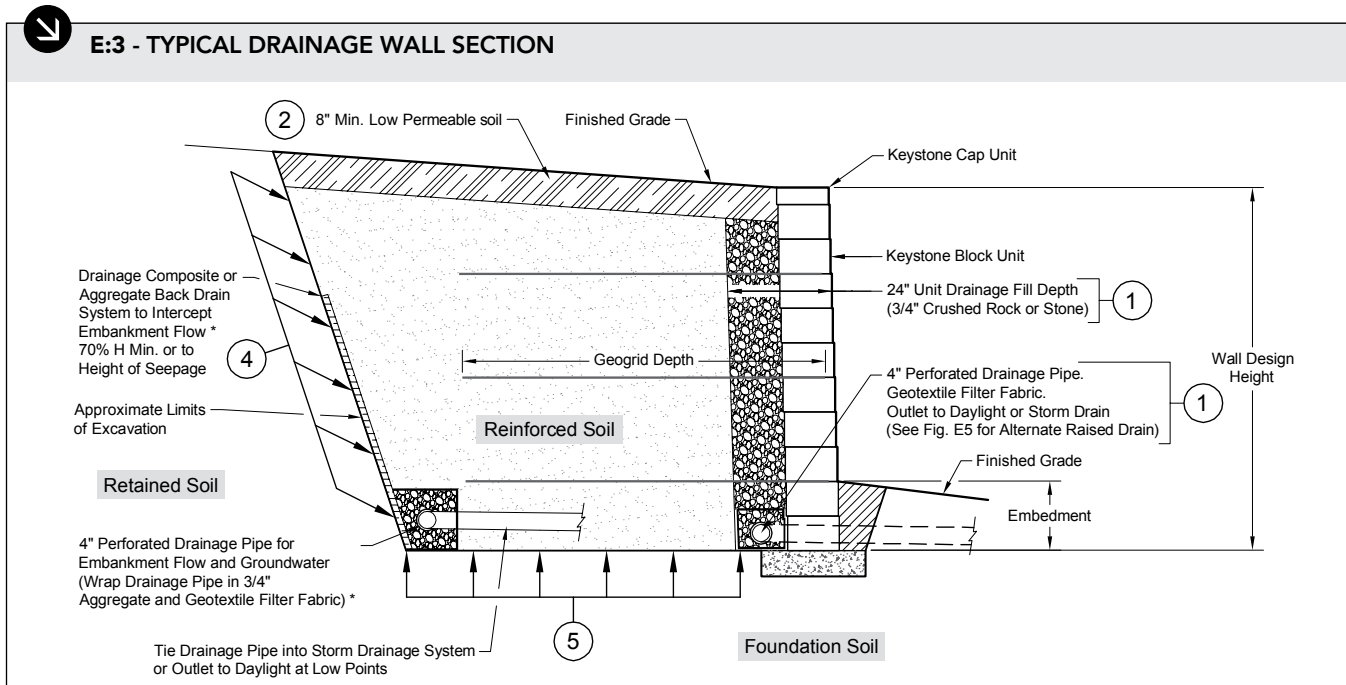

NOTES:

- Rear drainage pipe should be included when: groundwater or seepage is present in retained soils; springs or seasonal seepage potential is noted in geotechnical report; reinforced soil is of lower permeability than retained soils.
- Generally, additional drainage material such as aggregate drains and fabrics and/or drainage composite boards are used in conjunction with a rear drainage pipe, as directed. When above conditions are not present or groundwater conditions are not a factor, the rear drainage pipe may be omitted.
- When required, size, location and specific drainage materials should be completed as directed by the site geotechnical engineer.

The information contained herein has been compiled by Keystone Retaining Wall Systems® LLC and to the best of our knowledge, accurately represents the Keystone product used in the applications which are illustrated. Final determination of the suitability for the use contemplated and its manner of use are the sole responsibility of the user. Design and analysis shall be performed by a qualified engineer.

Retaining Wall Drainage Options



E:4 - TYPICAL DRAINAGE/SWALE WALL SECTION

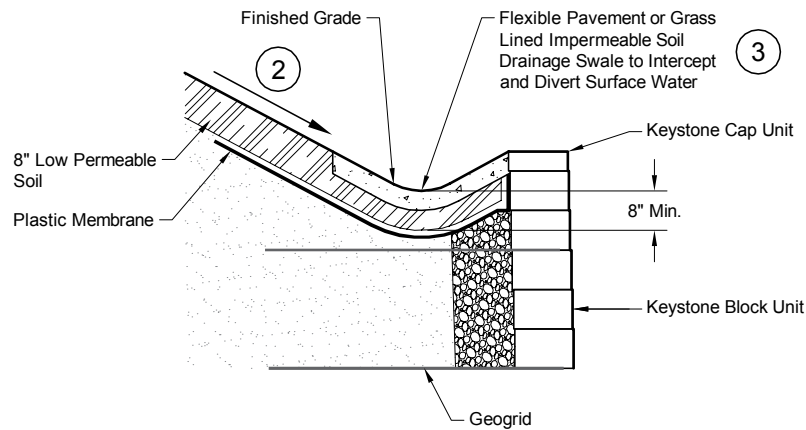

E:5 - ALTERNATE RAISED DRAINAGE PIPE LOCATIONS

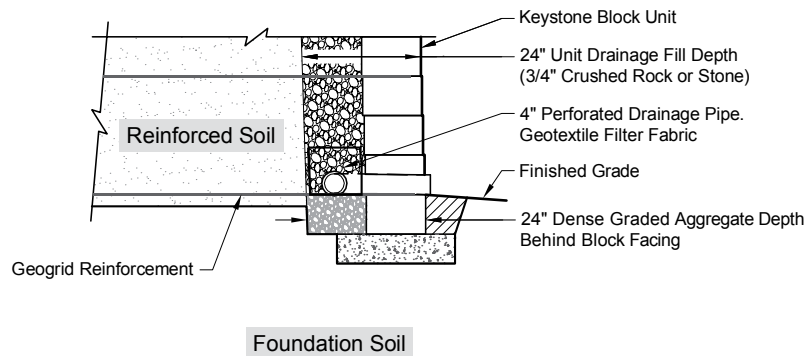

NOTES:

- Alternate raised drain pipe locations may only be used when (see Figure E:5, above):
 - The grade in front of the wall is flat and does not allow for gravity outlet of a pipe below the wall or through the base course of block.
 - There is no storm sewer system to outlet pipe directly into.
- Alternate locations are only used when site geometry requires drain pipe to be raised in order to outlet at face.

Storm Drain Outlet

Placement of storm drain outlets through the wall face are a common application. Since it is not possible to cut the block in a curve to fit tightly around the pipe, it is recommended that a cast-in-place collar be built around the pipe. The wall units can then be cut to the appropriate length and butted closely to the sides of the collar. Care should be taken to position the top of the collar within $\frac{1}{2}$ - 1-inch below the horizontal joint of the block above. This action will allow placement of the next course of units onto a wet set mortar bed to achieve horizontal wall alignment.

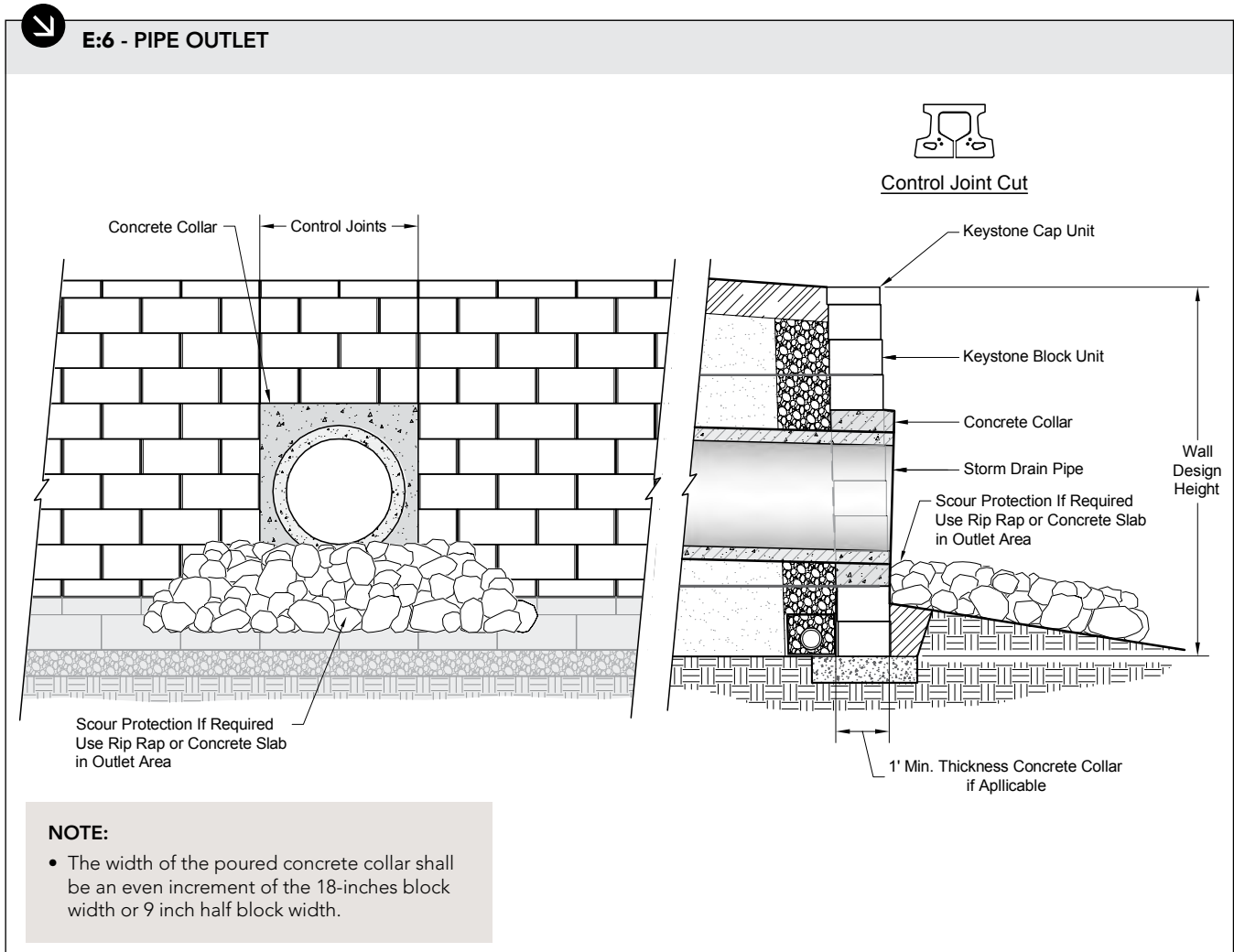

NOTES:

- A "control joint" should be constructed from the top of a concrete collar to the top of the wall. This control joint consists of saw-cutting a joint, from the face of the block back 3.5-inches minimum at the midpoint of the units on every other course.
- Provide splash block, concrete gutter or rip-rap for storm drain pipe outlet for scour protection, as required.

Barriers: Introduction

Keystone walls can readily be installed with many types of barrier systems. There are two main types of barriers: pedestrian fall protection devices and vehicular barriers.

Pedestrian fall protection devices come in various forms such as railings and fences. Most public design codes require some form of fall protection when a retaining wall reaches a specified height. Please contact your local building officials for code requirements in your area to determine if and when a fall protection device is required for your retaining wall. Keystone recommends fall protection be installed for all walls over 3-feet in height.

In general, vehicular barrier systems typically fall into two categories, flexible guide rails and rigid impact barriers. Flexible guide rails are the most common traffic device due to the simplicity of installation and the fact that they are typically more cost effective than a rigid option.

When a flexible guide rail is not an option, typically due to traffic type or insufficient room, often times a rigid cast-in-place (CIP) concrete traffic barrier is the next best solution. CIP concrete traffic barriers are most commonly used in DOT applications, but can also be specified in private application roadways with heavy traffic areas. CIP concrete traffic barriers can vary greatly by the application type, location, or design codes. Refer to state DOT agencies for specific details related to traffic barriers and MSE walls.

Guide Rails

When installing a guide rail with a Keystone wall, there are three important guidelines that must be met as mandated by The American Association of State Highway Transportation Officials (AASHTO).

1. The guide rail must be located a minimum of 3-feet from wall face.
2. The guide rail post shall be placed a minimum 5-feet into the ground.
3. The guide rail shall extend through a minimum of 2 geogrid layers.

There are a number of installation methods for a guide rail with a Keystone wall. Always reference the project-engineered drawings for the preferred installation method.

1. Preferred method: sleeves can be installed during construction to allow for the placement of guiderail foundation posts after wall construction.
2. Steel posts can be driven into the ground after wall construction. Care should be taken to ensure that a sufficient depth of compacted soil is in place above the upper layer of geogrid prior to driving any post systems. Displaced wall units or geogrid reinforcement should be repaired.

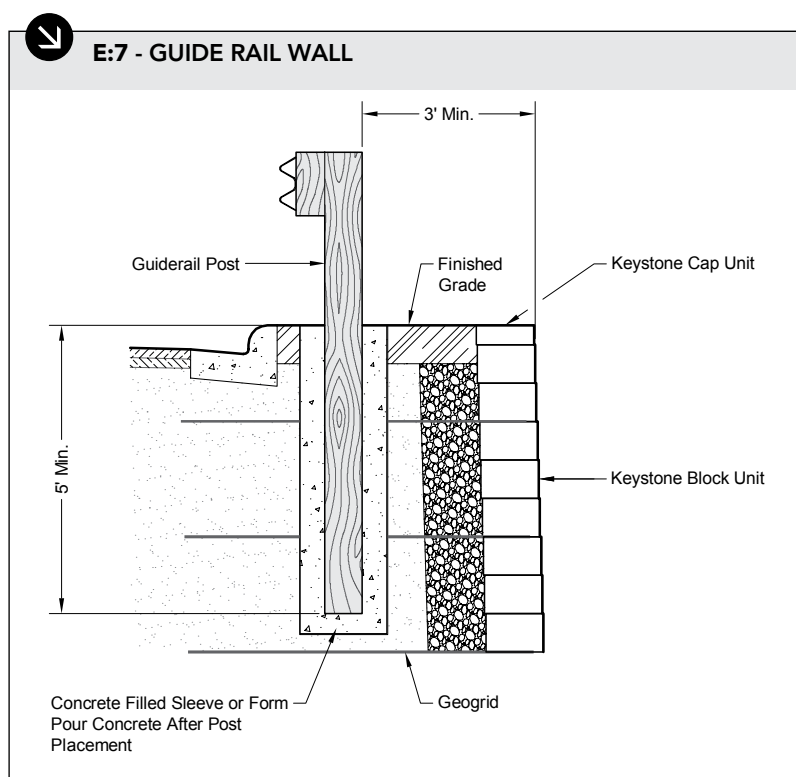

Barriers: Fencing Options

Fences can be placed at the top of a Keystone wall with fence posts placed behind the Keystone units. The choice, location, and compliance with local codes of the appropriate fall protection system, is the responsibility of the owner and site engineer. Follow these procedures for proper installation of fence posts with Keystone walls.

1. Install the Keystone wall per general installation instructions.
2. Fence posts positioned behind the Keystone units may be installed and anchored using a variety of installation methods.

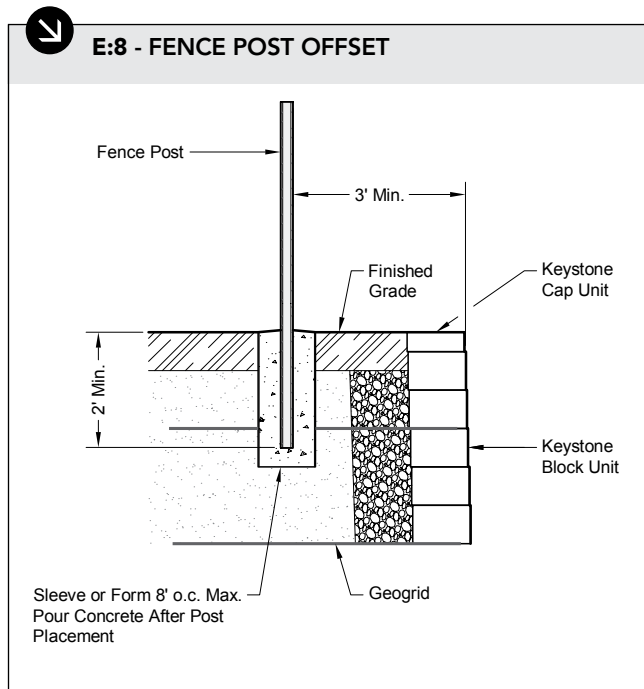

E:8

- Fence post placed at least 3-feet behind wall face shall extend a minimum 2-feet in the ground.

E:10

- The rigid sleeve or form should be placed during the wall construction at the horizontal location. Do not auger through the geogrid after wall construction.
- Place 3 to 4-feet (min. depth) sleeve or form passing through a minimum of two layers of geogrid when placing sleeve directly behind unit.

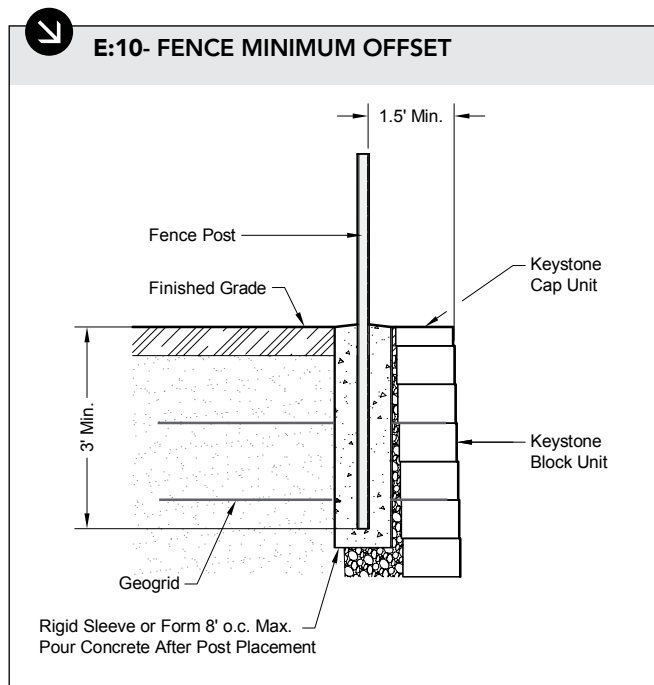
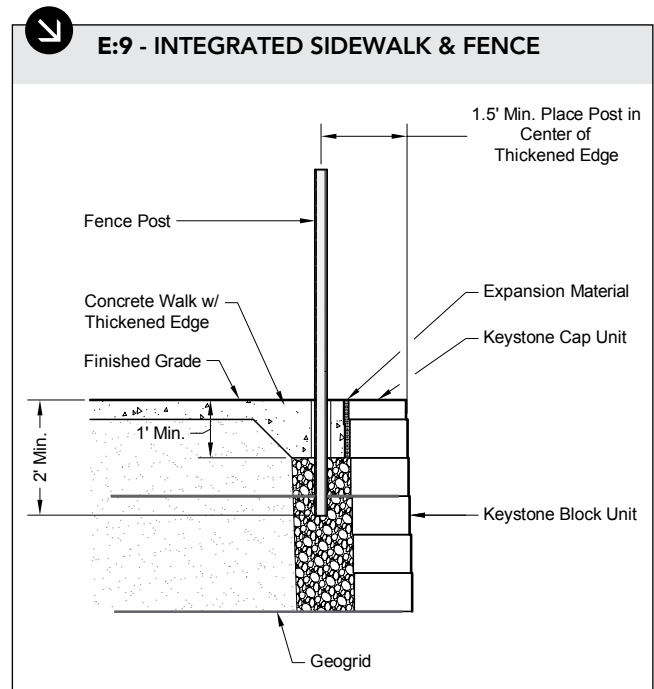

Terraced Wall Application

Terraced Keystone walls can provide a visually appealing solution to grade change. Slope conditions below, between and above the walls, soil conditions, and the horizontal distance between the walls will impact terraced wall design. In many cases, the geogrid lengths of the lower wall will be longer than typical to satisfy stability requirements. Always consult a qualified design professional for assistance with terraced walls.

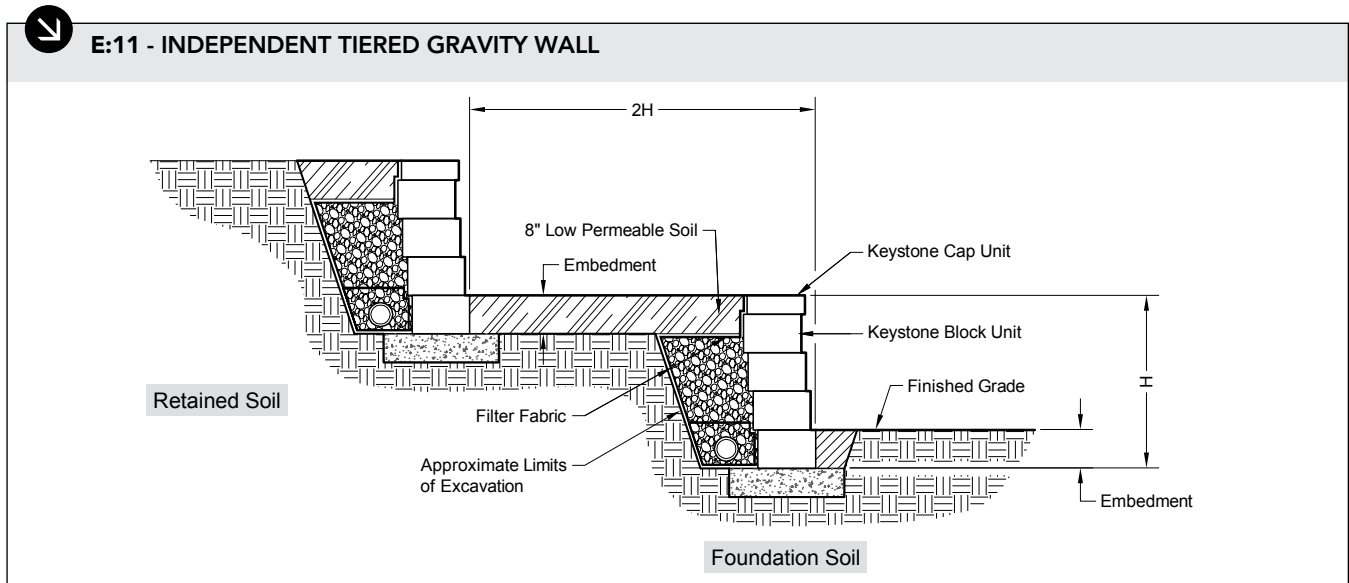

NOTES:

- For gravity wall designs and for individual walls to behave independently of each other, the horizontal distance between walls must be at least $(2H)$, $2 \times$ design height of the lower wall. If the distance between the walls is less than $2 \times$ design height of the lower wall, the lower wall must be designed with upper wall loading consideration. Always consult with a qualified engineer for geogrid reinforced and tiered wall designs. Lower wall height must be greater than upper wall height. All grades around all walls must be level. If the $2H$ rule does not apply, the walls dependent on each other and geogrid reinforcement will be required. (see Figure E:12, below)
- Railing or fall protection, as per local codes.

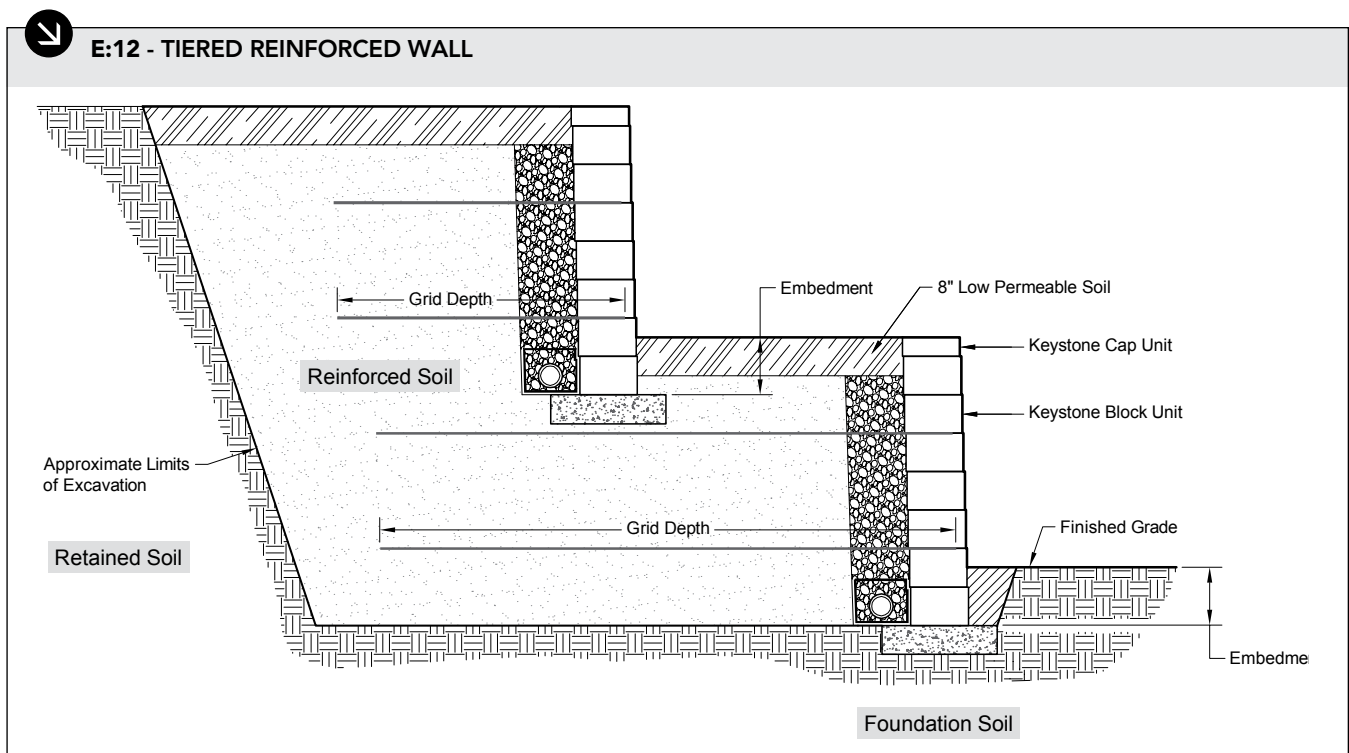

The information contained herein has been compiled by Keystone Retaining Wall Systems® LLC and to the best of our knowledge, accurately represents the Keystone product used in the applications which are illustrated. Final determination of the suitability for the use contemplated and its manner of use are the sole responsibility of the user. Design and analysis shall be performed by a qualified engineer.

Planting Guidelines



E:13 - PLANTING LIMITS BEHIND WALL

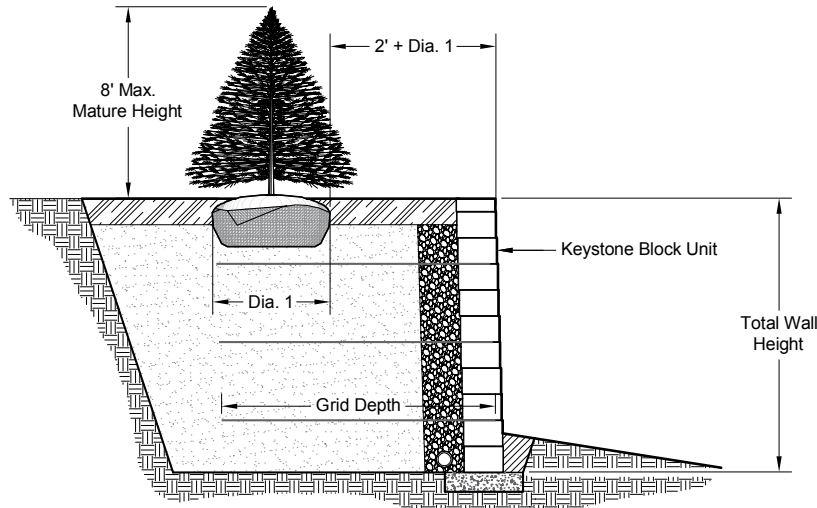

Planting

1. Only the top layer of the geogrid may be cut to allow planting of tree ball. Avoid disturbance of adjacent reinforcement. Mature tree height should not exceed 8 feet.
2. Extreme care should be taken if installing irrigation systems directly behind the wall so as to not damage the soil reinforcement during installation or have potential leakage into the retaining wall system. Leaking irrigation lines can saturate the backfill and create hydrostatic pressure and wall movement.
3. Utilize a root control barrier as required to avoid pressures or growth through the Keystone block units.
4. Numbers in parenthesis are for example only.



E:14 - PLANTING LIMITS BEHIND WALL

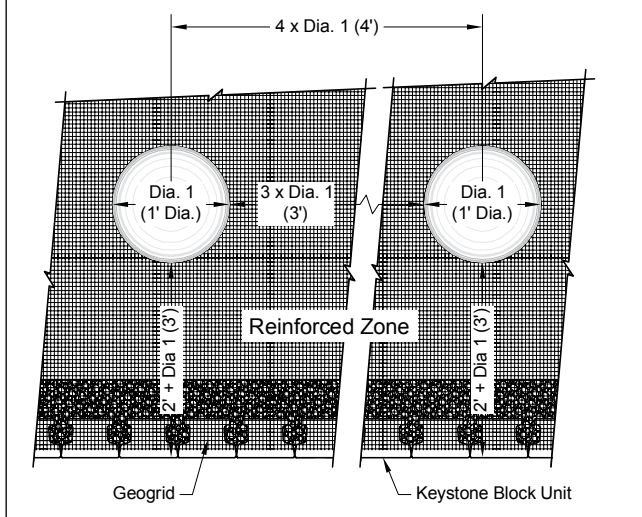

NOTES:

- All planting offsets shall be a minimum of 2-feet plus the root ball opening diameter as measured from the face of the wall.
- Lateral spacing between the openings shall be a minimum of 3 x the largest opening diameter.
- If trees are placed closely together and cutting of geogrid becomes excessive, consult with your wall design engineer or Keystone representative.

The information contained herein has been compiled by Keystone Retaining Wall Systems® LLC and to the best of our knowledge, accurately represents the Keystone product used in the applications which are illustrated. Final determination of the suitability for the use contemplated and its manner of use are the sole responsibility of the user. Design and analysis shall be performed by a qualified engineer.

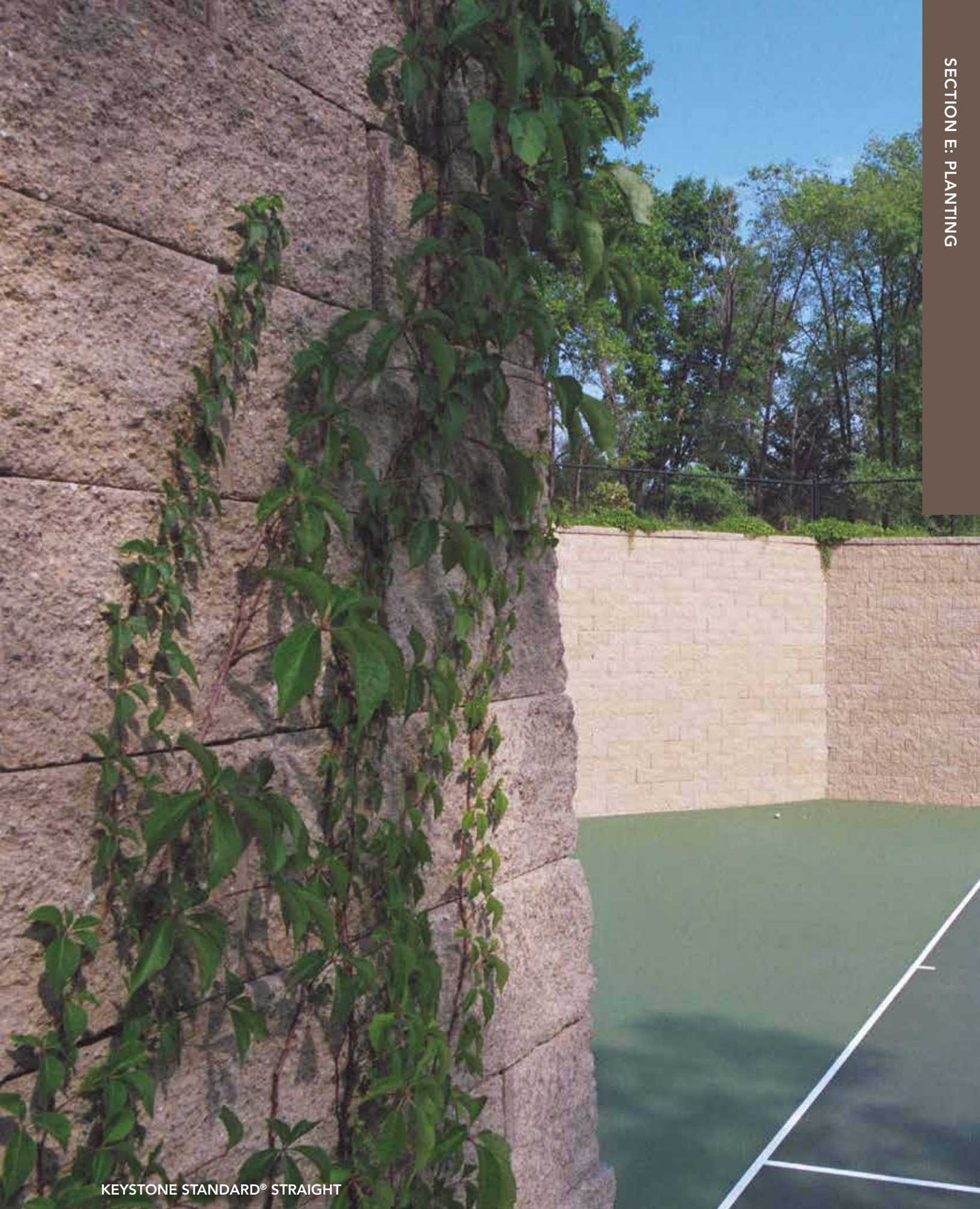

KEYSTONE STANDARD® STRAIGHT

Segmental Retaining Wall Care, Operations and Maintenance Guide

The Segmental Retaining Wall (SRW) is constructed of concrete masonry units, geogrid soil reinforcement fabric, and compacted backfill. The structure's performance is sensitive to any post construction activities that may damage components, increase loading conditions, and/or reduce overall stability. The following list is intended to provide guidelines for the proper care of a SRW.

1. The area behind the wall that contains geogrid soil reinforcement fabric (reinforced zone) is the primary structural component of the wall system. Do not, under any circumstances, excavate through, drill through, or otherwise damage this reinforcement fabric without written approval of the design engineer of record.
2. The drain line at the base of the wall (if required and installed) was stubbed out to daylight or for final connection to storm drainage systems by others. Please insure that all connections are made to proper drain outlets and that any drains outlets to daylight are not buried.
3. The Keystone wall is normally constructed over a crushed stone base. No digging or excavation shall be done within 3 feet horizontally from bottom face of wall or to such depth that would compromise the integrity of the wall foundation.
4. All water must be diverted away from the base of wall to avoid erosion and undermining of the foundation after installation. This includes temporary site grading during construction and final site grading.
5. Landscape watering and surface drainage above the wall should be designed in consultation with the Civil and Geotechnical engineer and performed in such a way to avoid standing water, water cascading over the wall, and infiltration (saturation) of the reinforced zone.
6. Do not increase the height of the existing wall as constructed with more block units without the written approval of the design engineer of record.
7. Do not add a slope or increase the steepness of a back slope beyond what was considered in the original grading plan and wall design without written approval of the design engineer of record.
8. Do not add additional surcharges within a lateral distance of twice the overall height of the structure(s) without written approval of the design engineer of record or unless considered in the original wall design. This would include large trees, fences, sound walls, landscaping walls, swimming pools, buildings, garages, etc.
9. Do not operate heavy equipment, within four feet of top of wall face. The surcharge from equipment weight can push the upper wall units out resulting in unacceptable misalignment.
10. Segmental retaining walls are flexible structures (vs. rigid as in CMU walls) and are subject to some post construction settlement and movement. All structures (i.e. sidewalks, pavements, curbs, trash enclosures, utility lines, etc.) should be designed to handle some ground movement and not be connected directly to the wall units.
11. Retaining walls should be inspected at least once a year. Some, but not necessarily all items to be inspected are; verify that drainage measures are functioning properly, erosion has not occurred along the top, ends, or bottom of wall(s), landscaping and planting is not interfering with the wall(s) intended performance, observe and note any unanticipated movement or deflection of the wall system and evaluated by a qualified engineer. Additional inspection may be necessary immediately following a catastrophic event such as a flood, heavier than normal rain event, earthquake, etc.
12. Over time the wall face may begin to show a white flaky material and may especially be noticeable post construction. This material is called efflorescence. Efflorescence occurs when moisture evaporates from the wall face, and the naturally occurring soluble salts and bases, or the calcium carbonite (calcium hydroxide in the cement mixes with carbon dioxide in the air) is left on the face. This efflorescence is only an aesthetic concern and will not affect the structural performance of the wall. Efflorescence can typically be removed by dry brushing followed by flushing with clean water. In tougher cases power washing with muriatic acid solution will also aid the cleanup process. For additional information and removal options reference NCMA Tek bulletin 8-3A.

The information contained herein has been compiled by Keystone Retaining Wall Systems® LLC and to the best of our knowledge, accurately represents the Keystone product used in the applications which are illustrated. Final determination of the suitability for the use contemplated and its manner of use are the sole responsibility of the user. Design and analysis shall be performed by a qualified engineer.



KEYSTONE COMPAC® VICTORIAN ASHLAR



DISTRIBUTED BY:

We reserve the right to improve our products and make changes in the specifications and design without notice. The information contained herein has been compiled by KEYSTONE and to the best of our knowledge, accurately represents the KEYSTONE product used in the applications which are illustrated. Final determination of the suitability for the use contemplated and its manner of use are the sole responsibility of the user.



www.keystonewalls.com



©2020 The QUIKRETE Companies - Patents Pending • KRW 10/2020

